

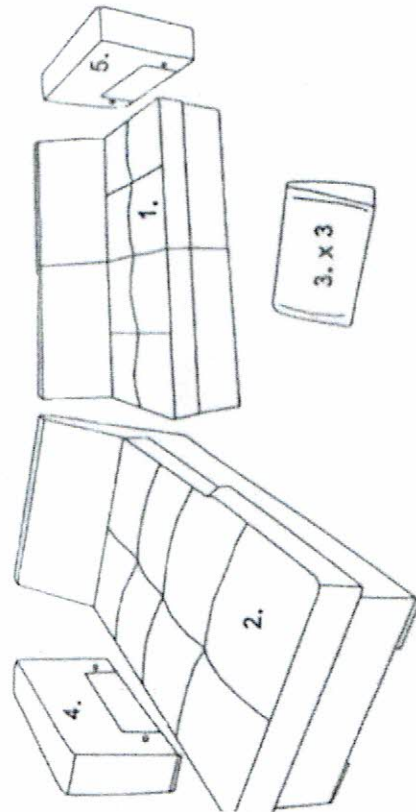

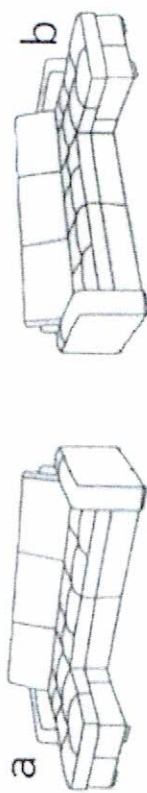

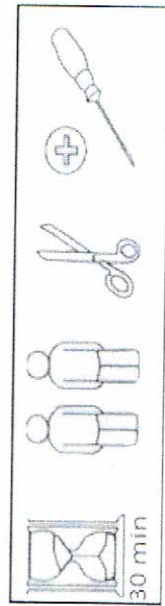

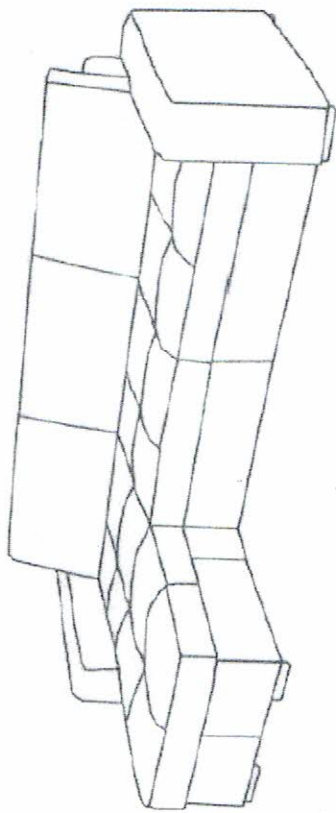

CINDY



A x8  M6 x20	B x4 	C x4  M8 x80	D x1  "5"
---	---	---	--

1	A x8  M5 x20	B 	 +
----------	---	--	--

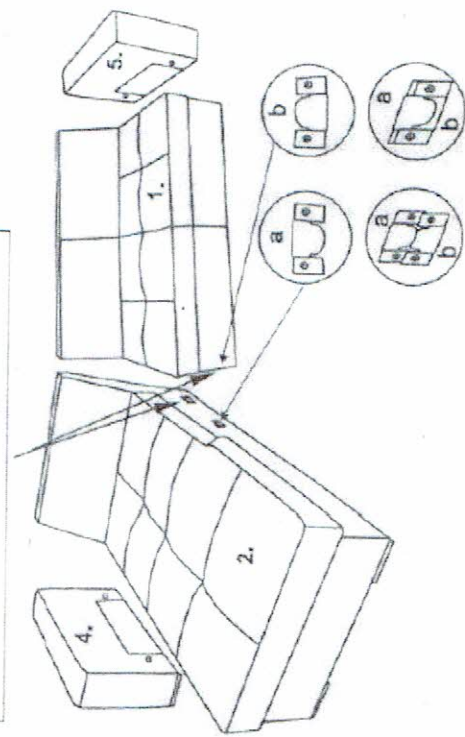
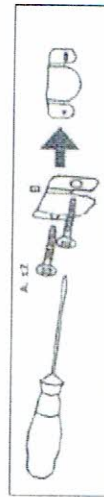

2

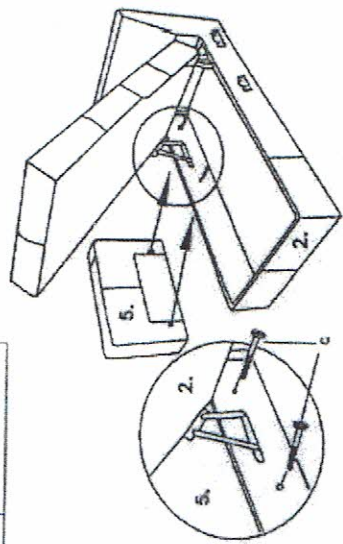
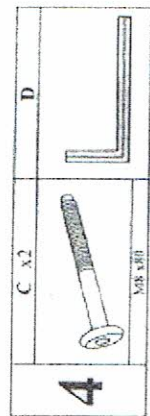
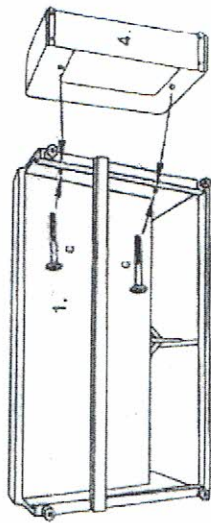
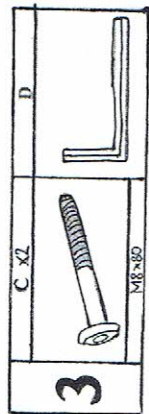
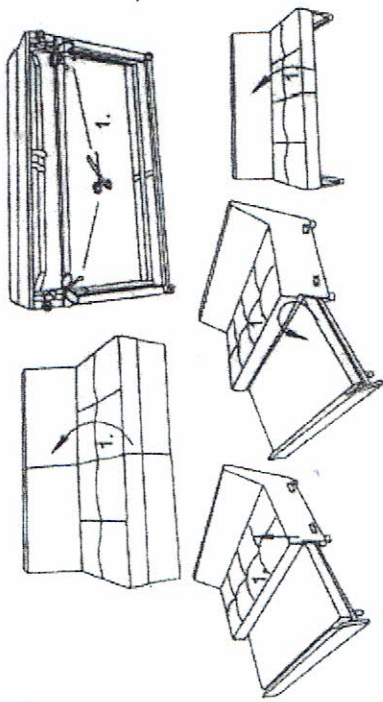

3

5

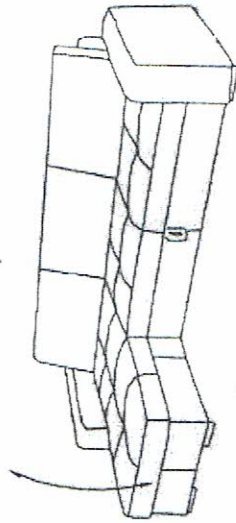
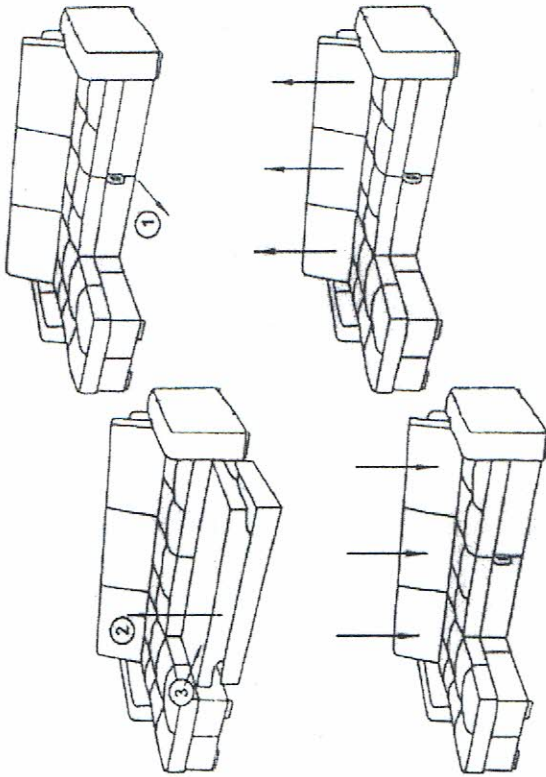
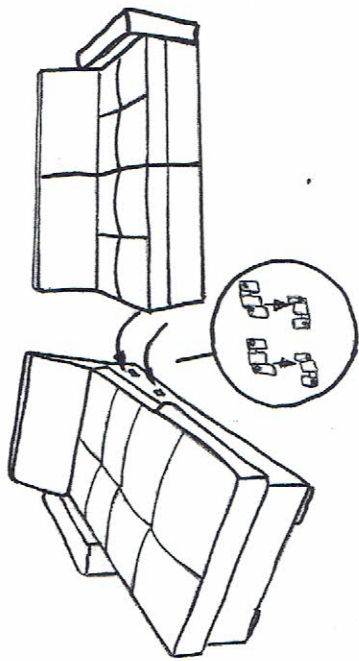

4