

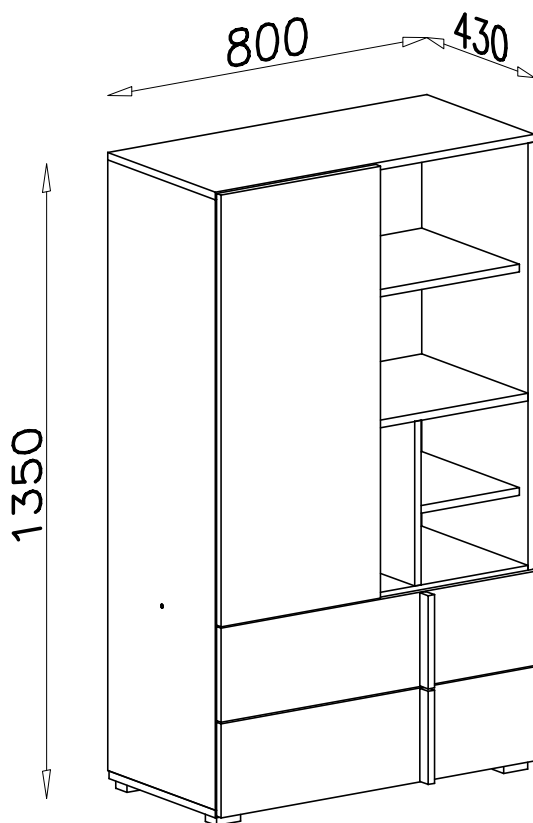

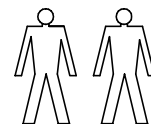

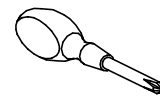

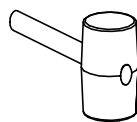

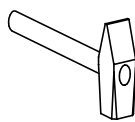
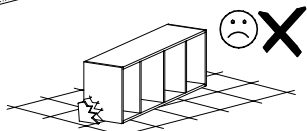
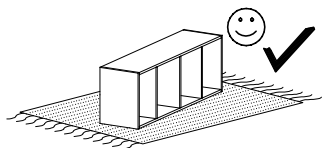
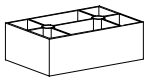

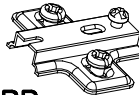
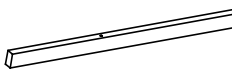

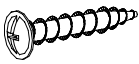
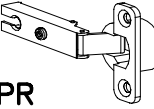
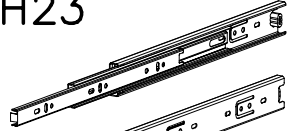
REMO RM 6

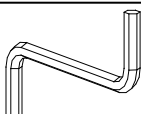

P2  x4	W1  x3	B2  ø6x30 x4	D3  PZ35PR x2	E1  198mm x2
G12  3,5x25 x8	G4  4x16 x4	G8  4x30 x2	C3  Z35PR x2	H23  350mm x2
A1  ø7x50 x9	B7  ø8x30 x43	G2  3x20 x50	S2  x10	G1  4x13 x20
		W2  x1	F1  x16	

I

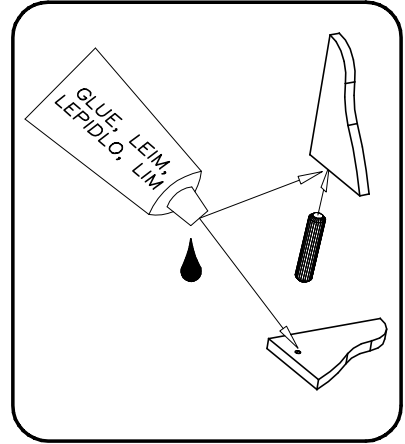
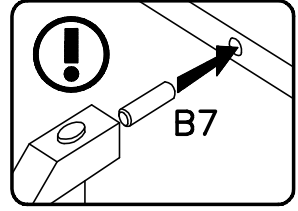
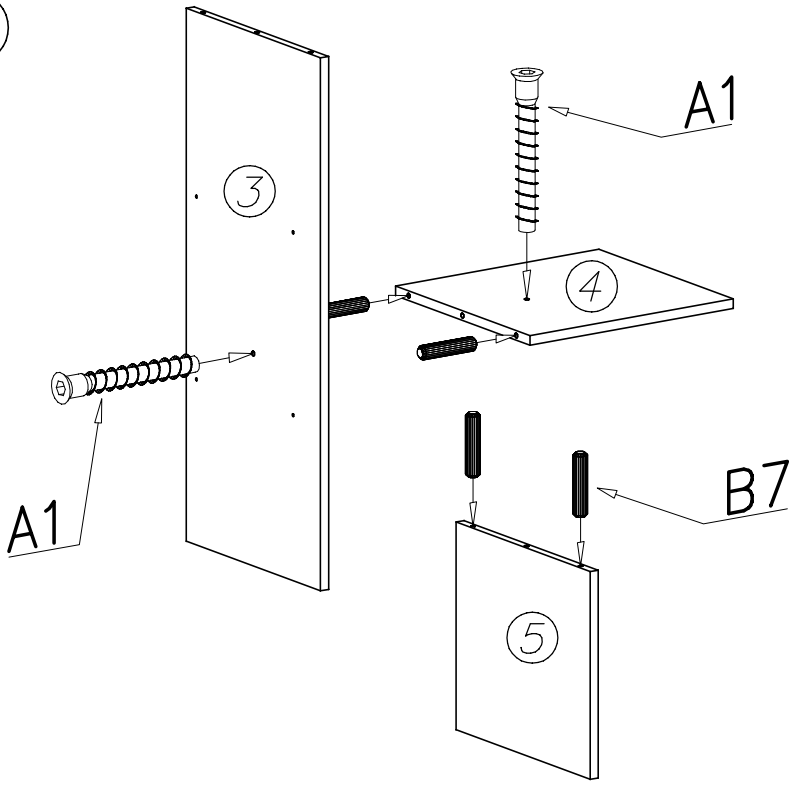

II

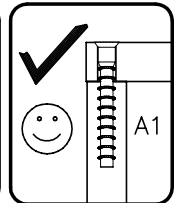
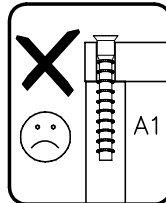
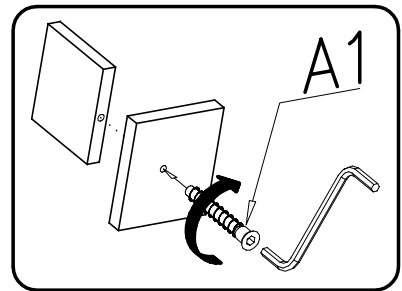
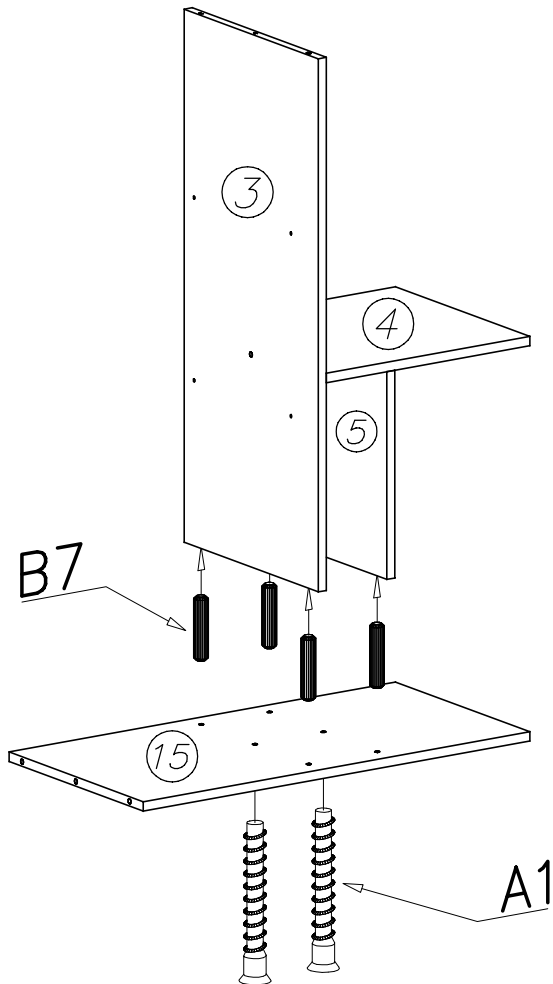

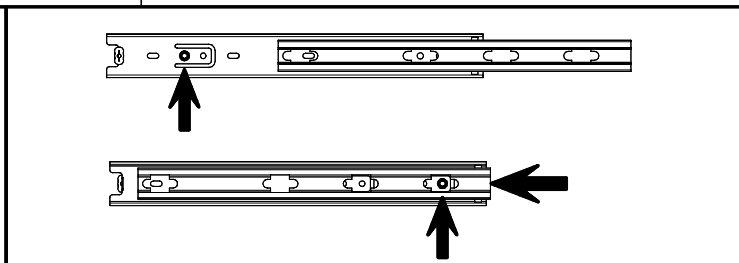
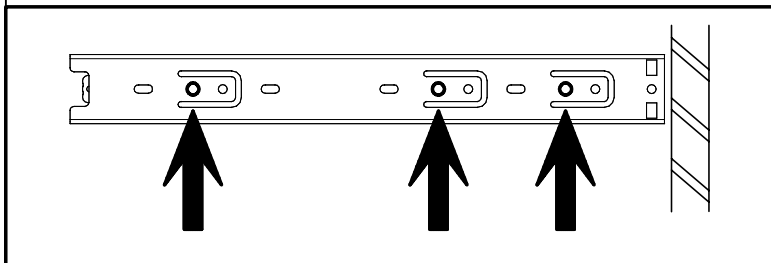
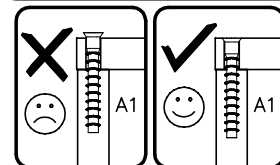
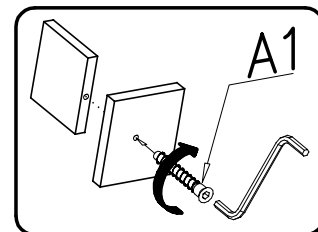
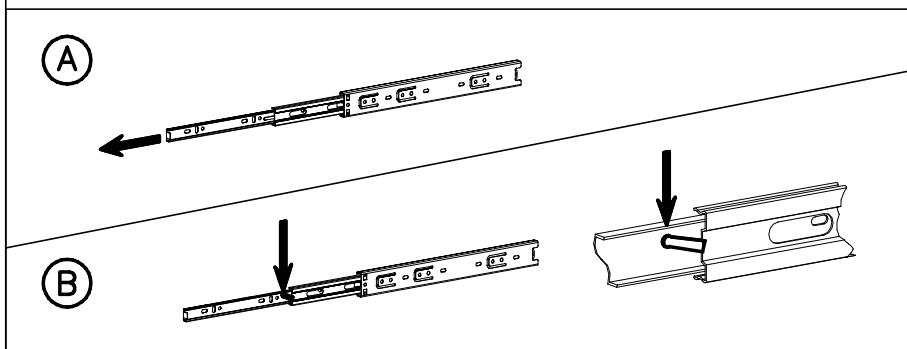
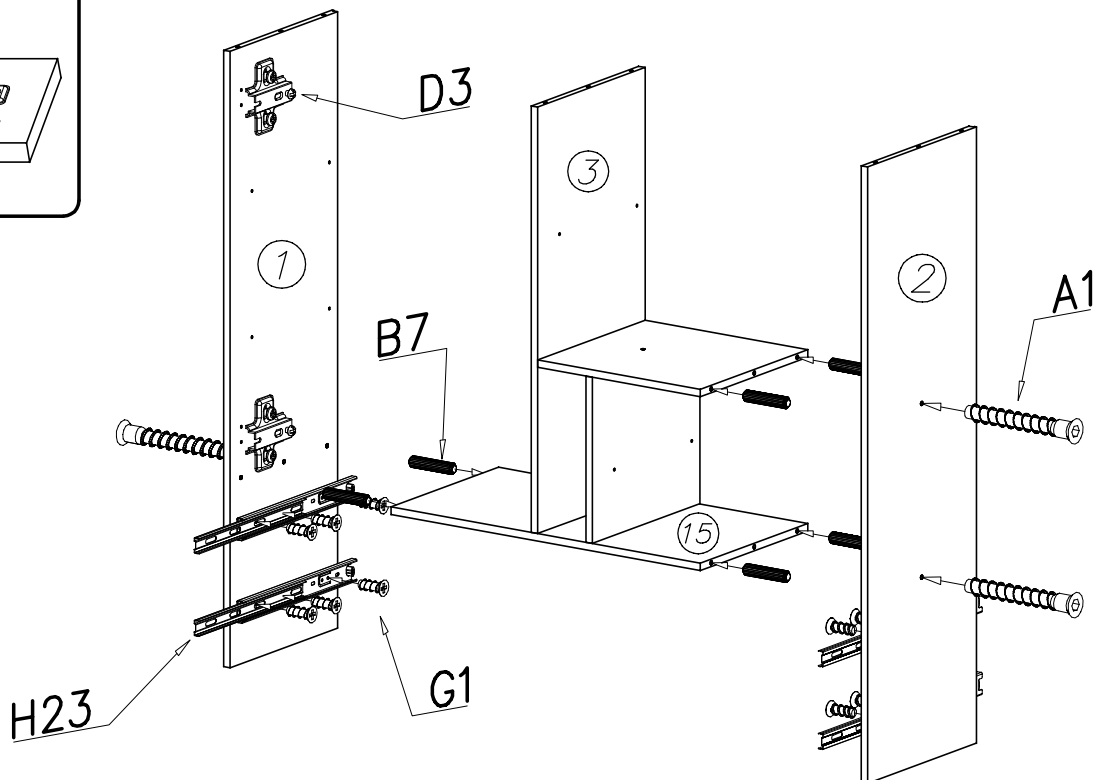
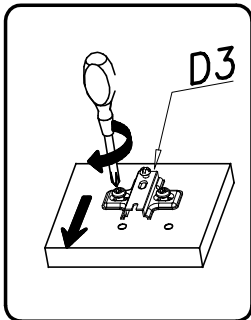
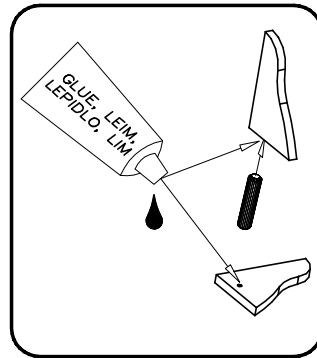
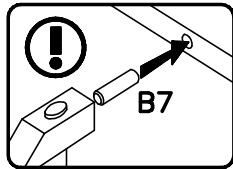

IV

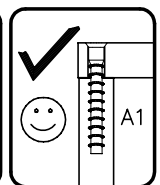
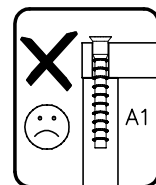
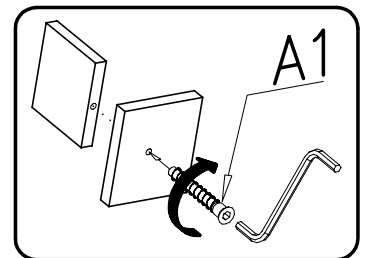
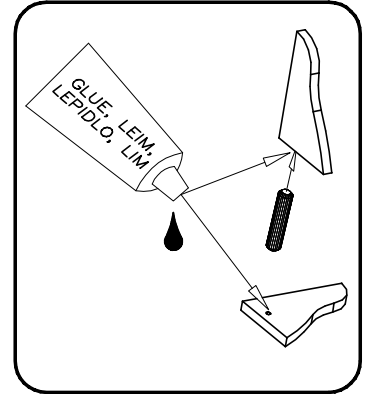
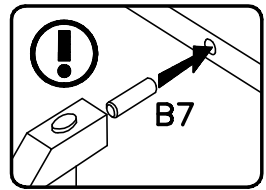
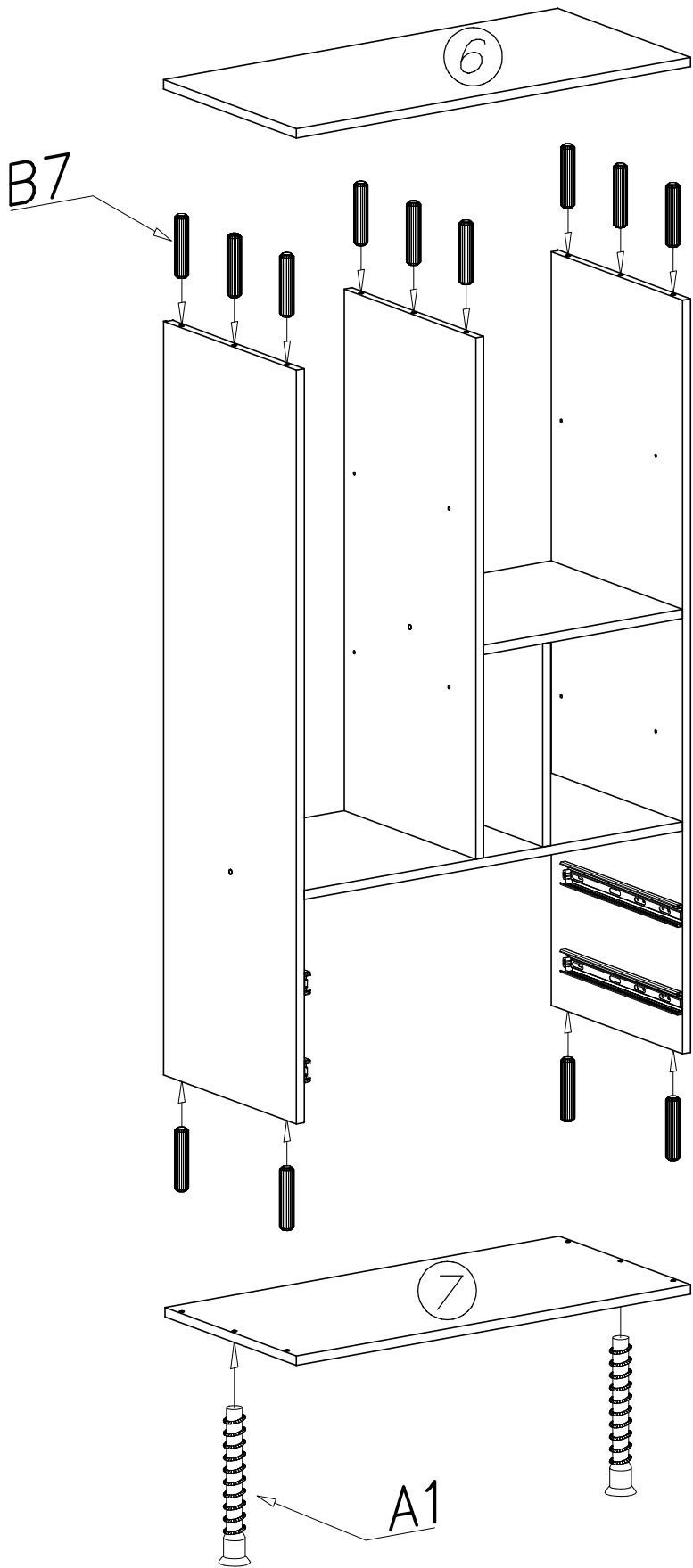

V

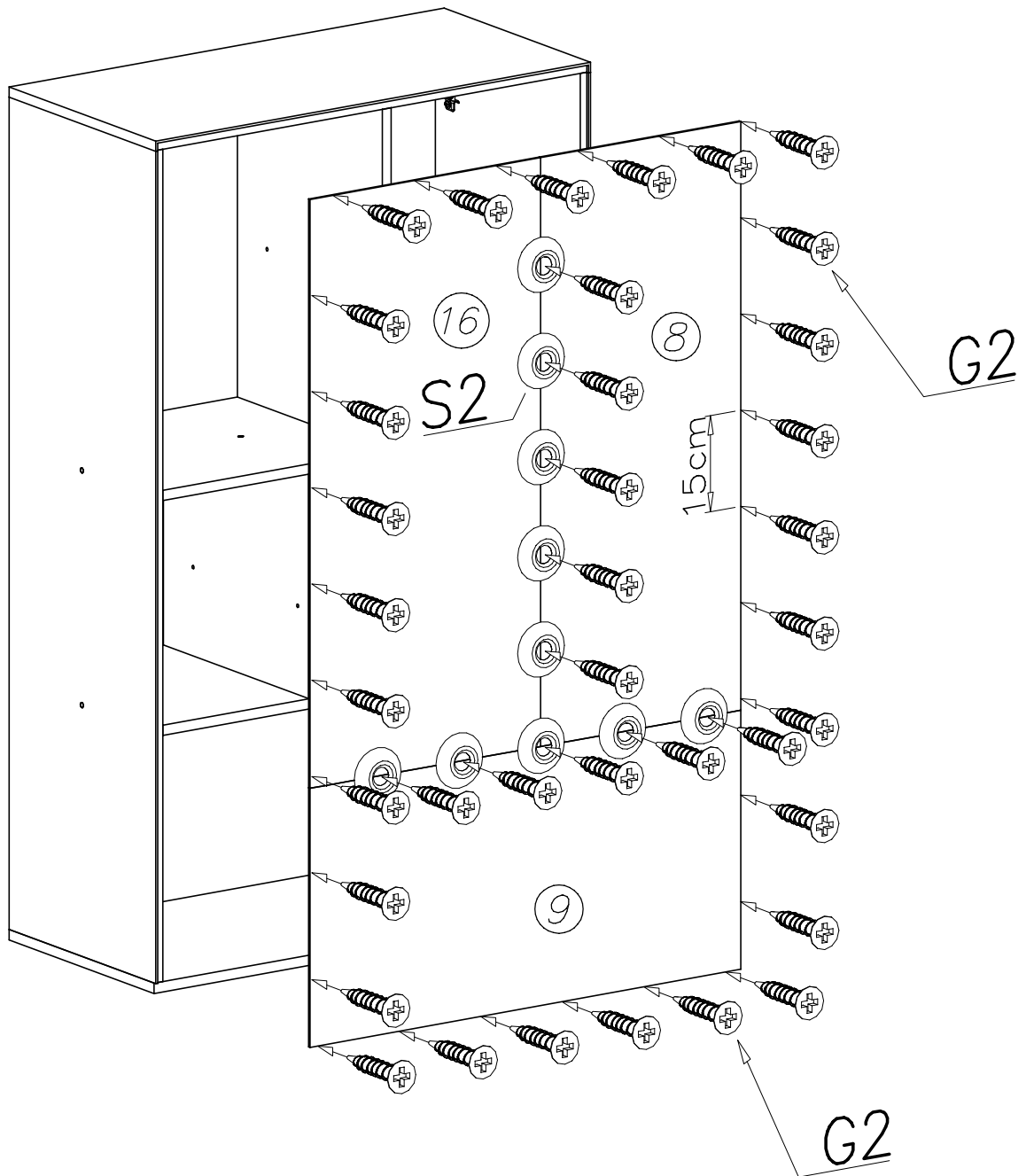
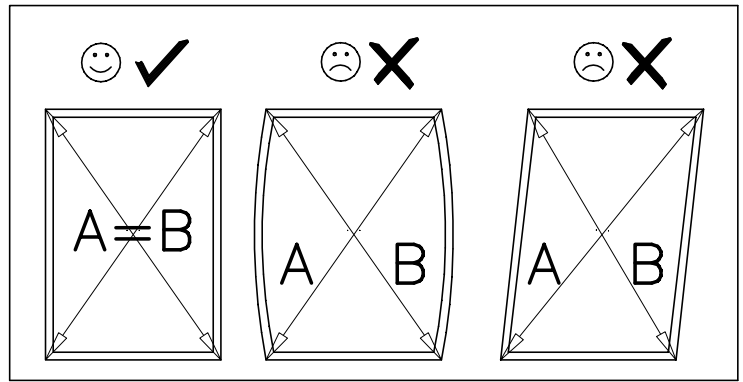

VI

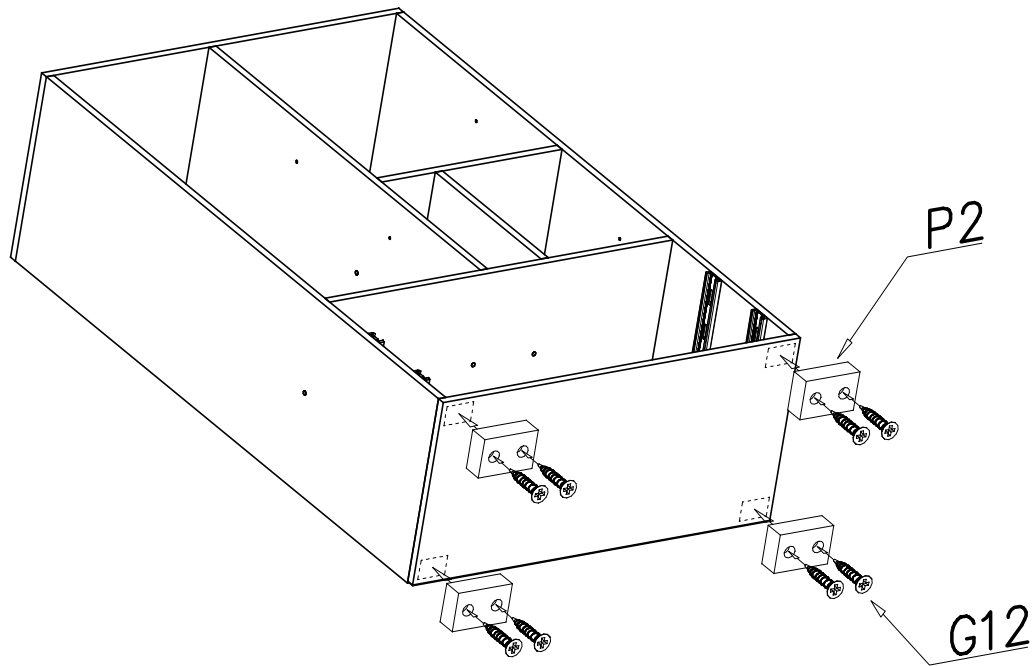

VII

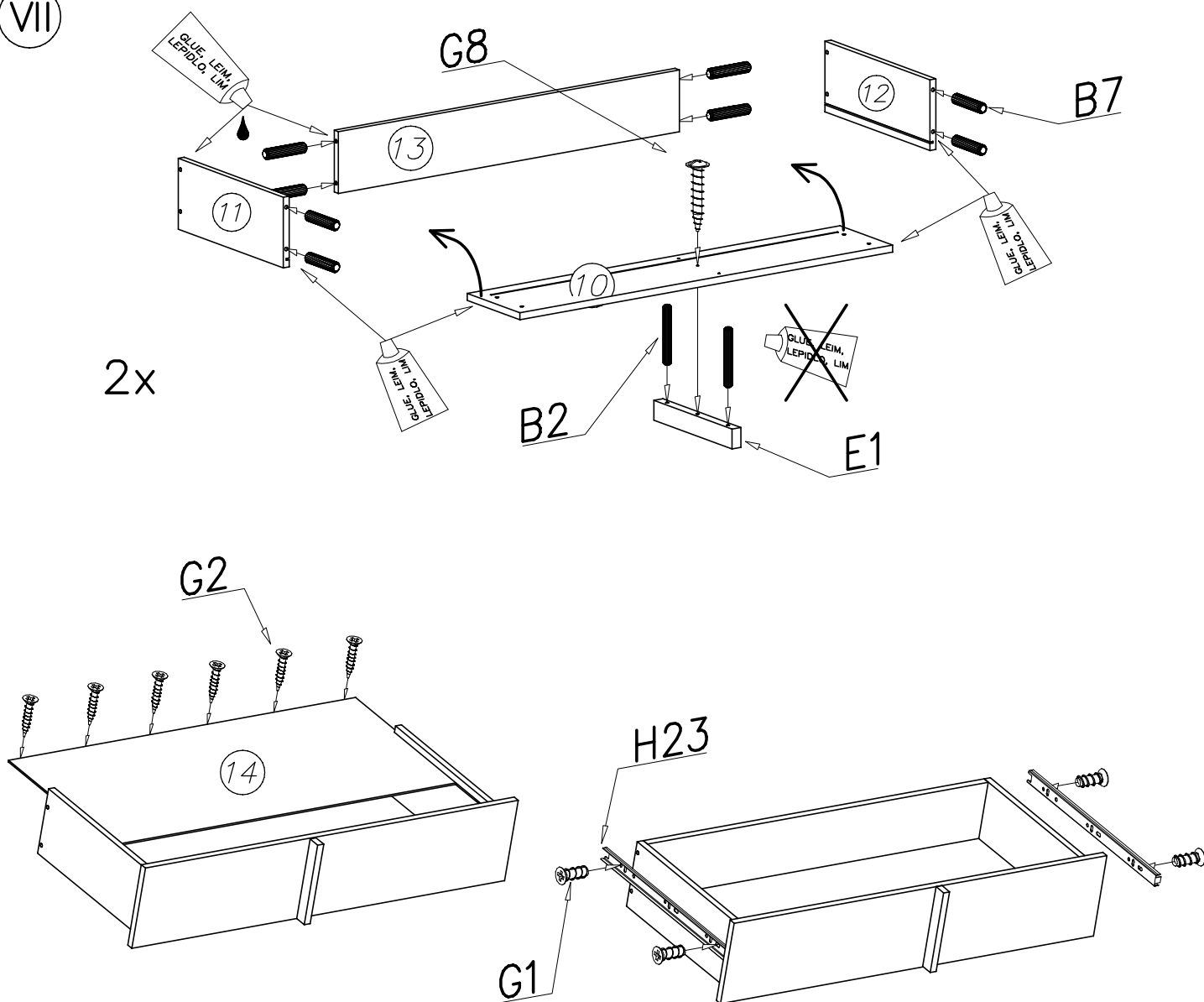

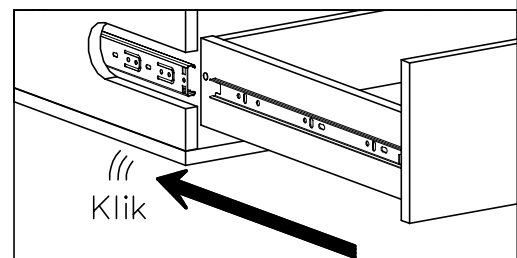
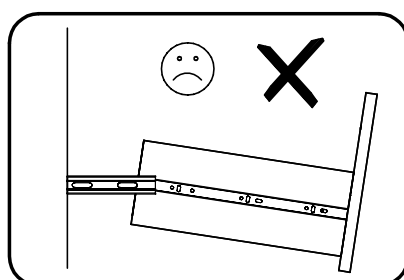
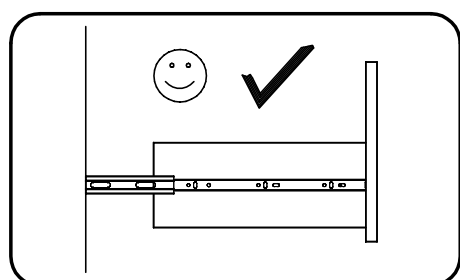
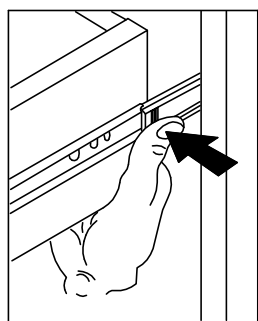
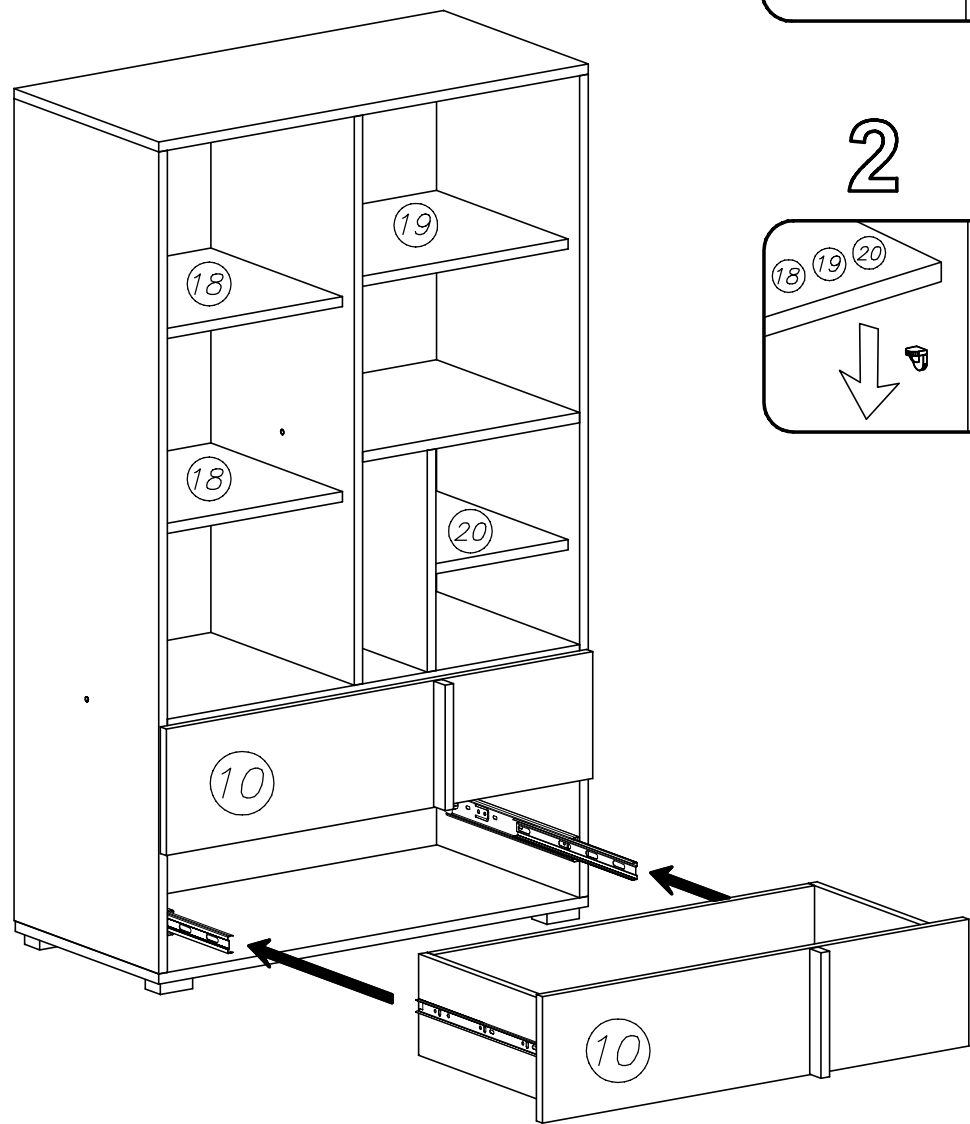
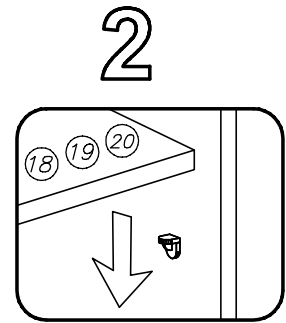
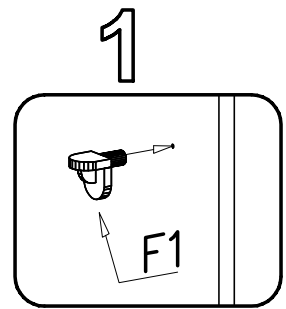

IX

