

# Installation manual

NORTON: POL\_130

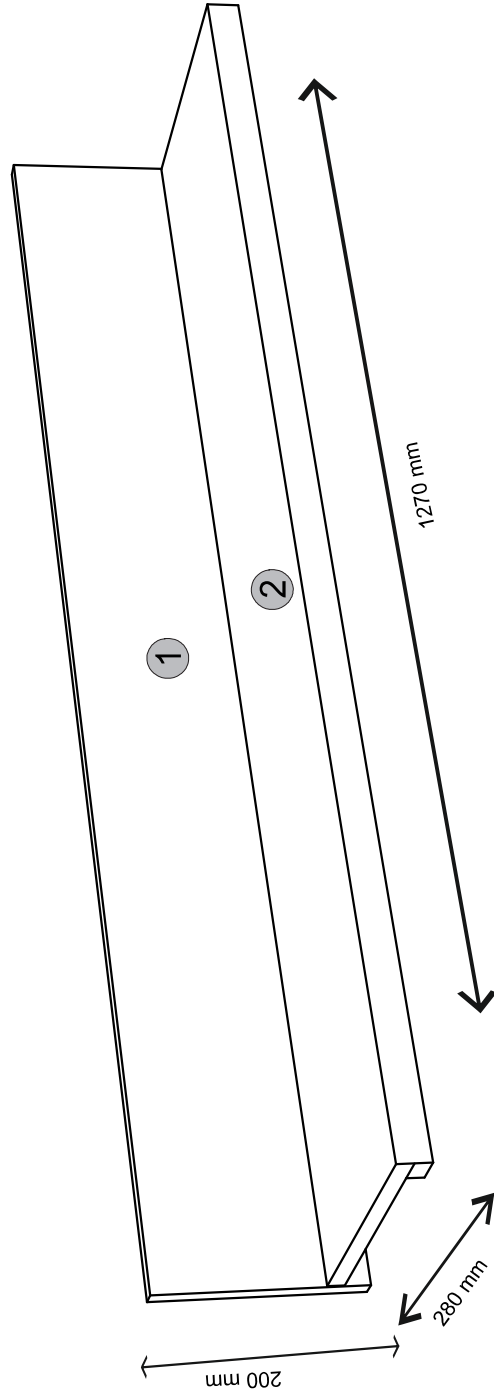
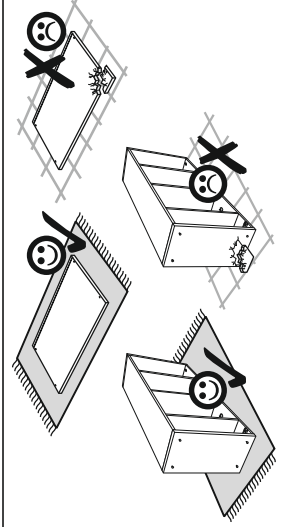
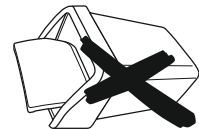
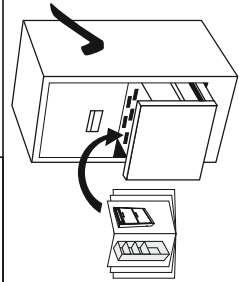
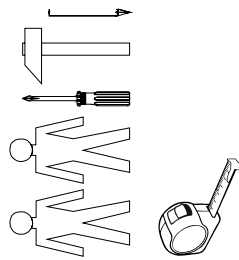
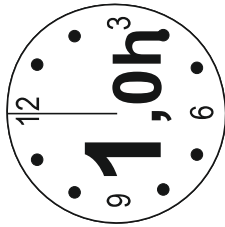
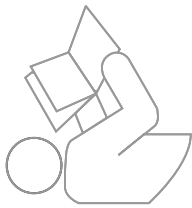

Element symbol	Dimensions	Code	Package
1	200 1270 16	1 K-102	1/1
2	1268 204 16\32	1 K-302	1/1

1x		z1	2x		2x		2x		e3	
5x		e1	2x		e19	4x		6x		f1
5x		s1	2x		p17	2x		2x		f3

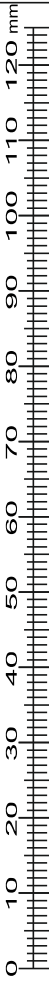

1

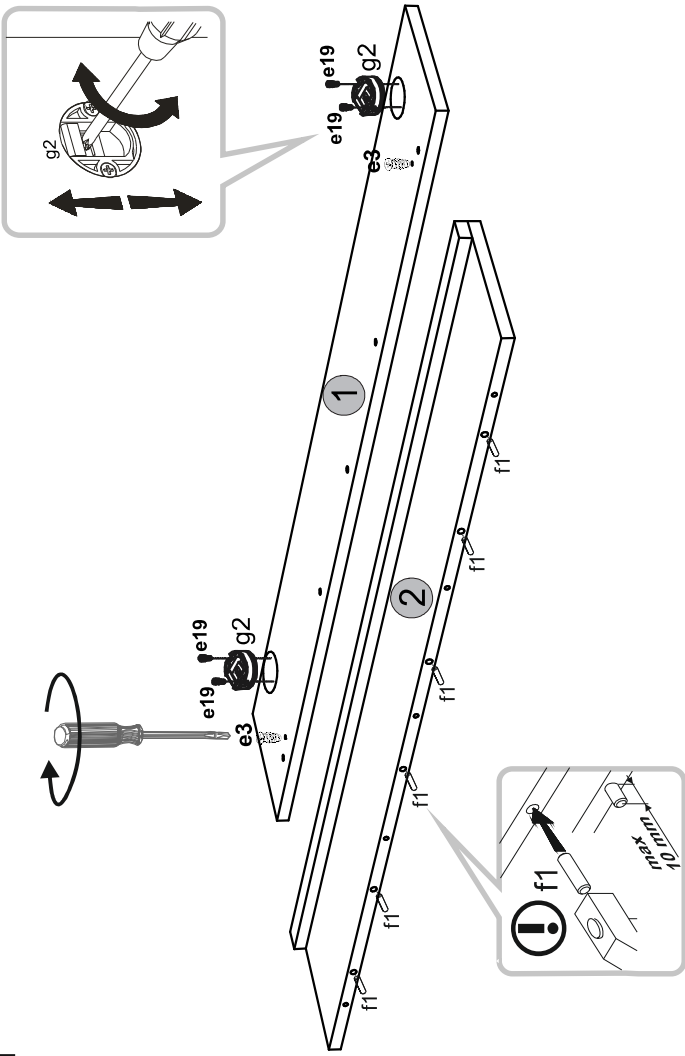

2

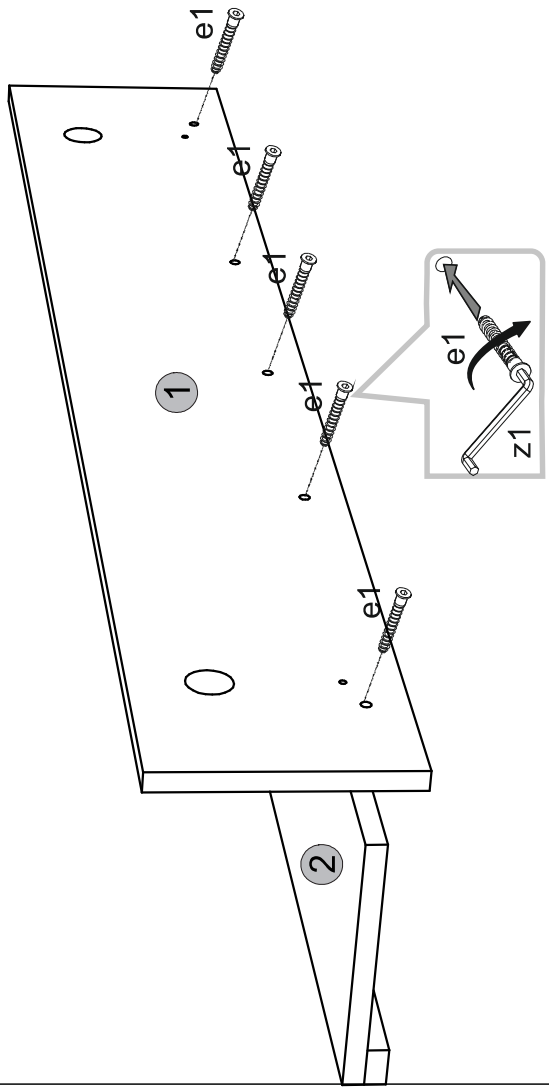

3

