

10

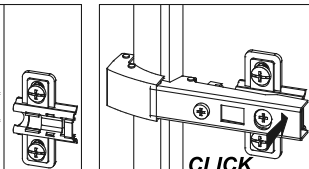

MODELL: SL08

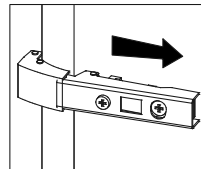
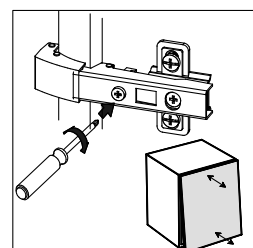
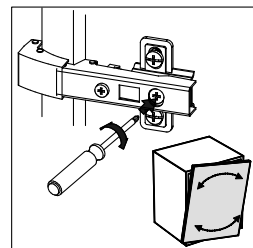
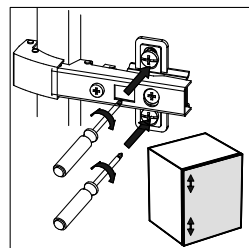
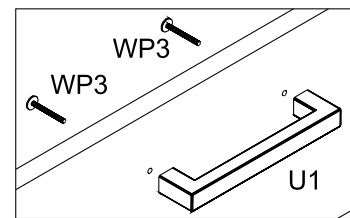
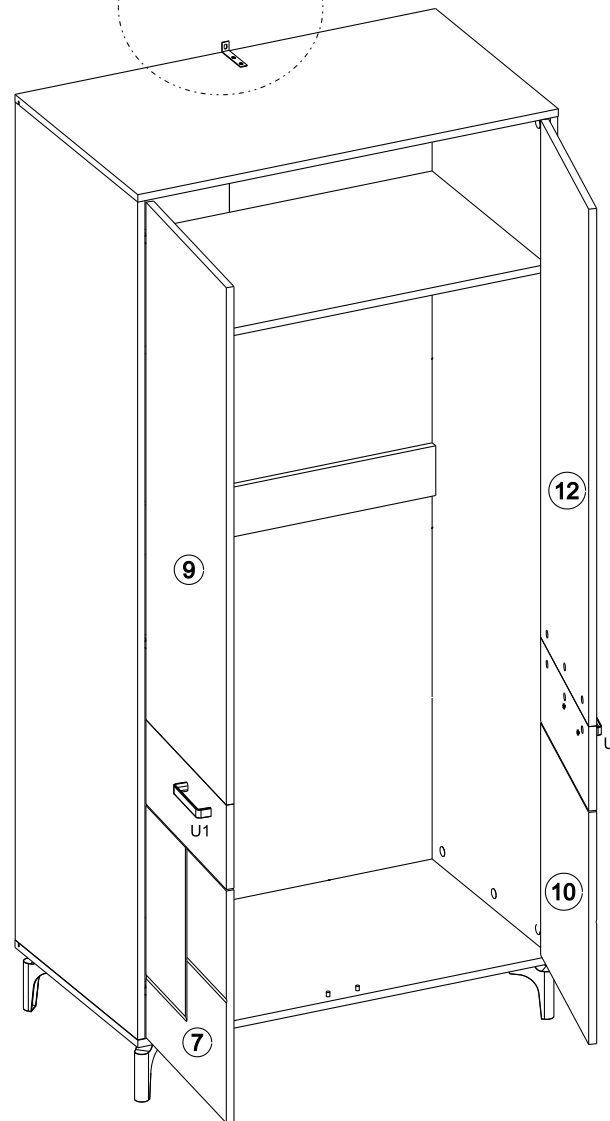
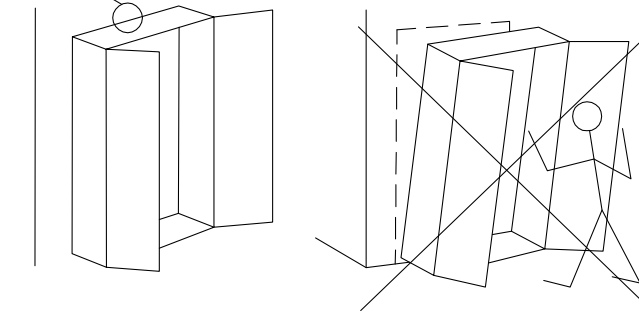
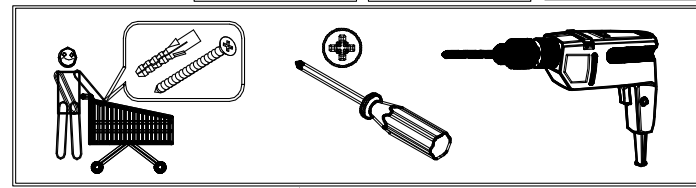
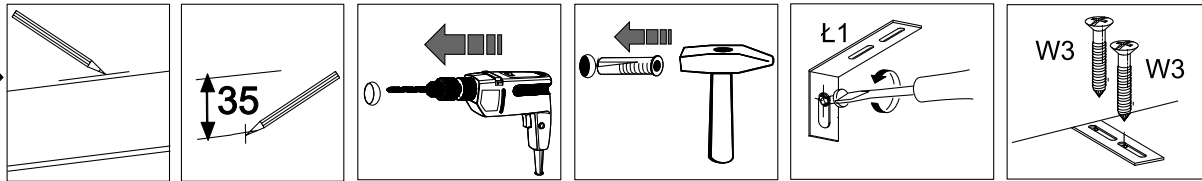
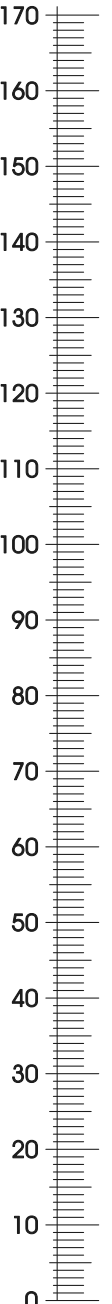
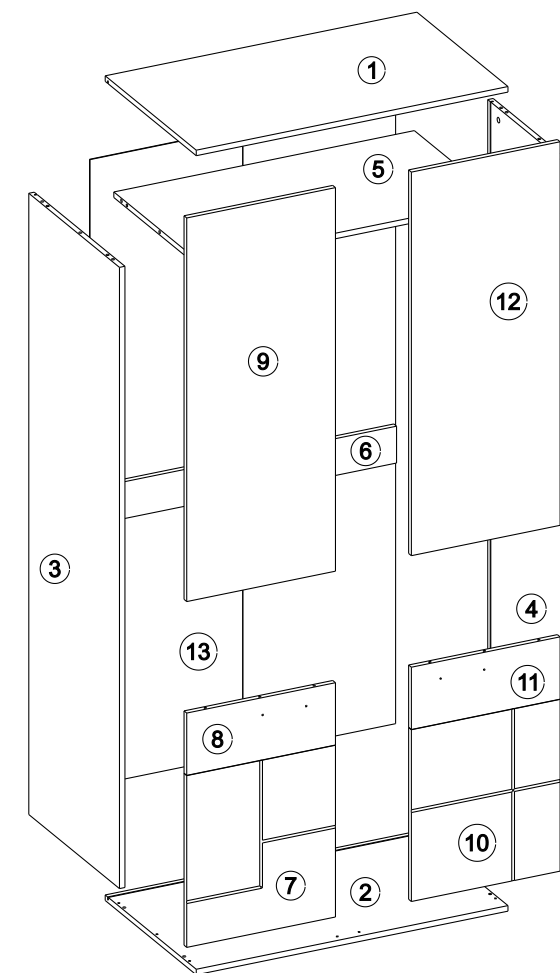
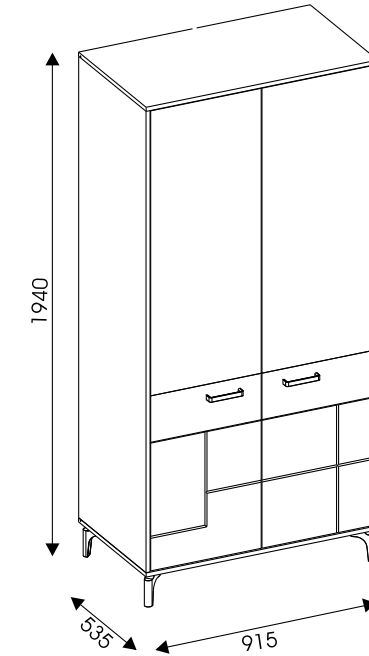
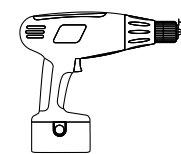
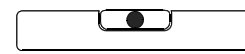
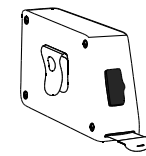
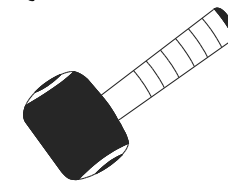
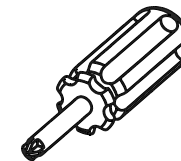
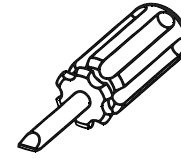
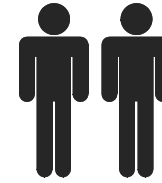
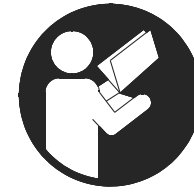

13	898x1803	2/3
12	1104x437	3/3
11	437x180	3/3
10	495x437	3/3
9	1104x437	3/3
8	437x180	3/3
7	495x437	3/3
6	883x106	1/3
5	883x498	1/3
4	1788x533	2/3
3	1788x533	2/3
2	916x535	1/3
1	916x535	1/3

6x ZC0									
18x #20/325 ZN1	18x 3.5x16 W3	14x ST1	3x 4x13 WP4	12x MK15/15 M3	14x 3x20 W9	2x B3	4x 4x27 WP3	4x N1	
1x N1	14x 8x30 K1	2x U 1	2x WS1	20 #15/15 M1	20x DU232T T1	6x #56 T3	16x 4x25 W6	1x L1	

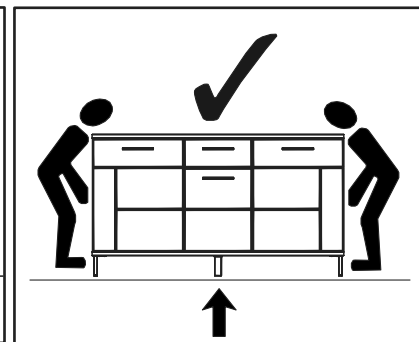
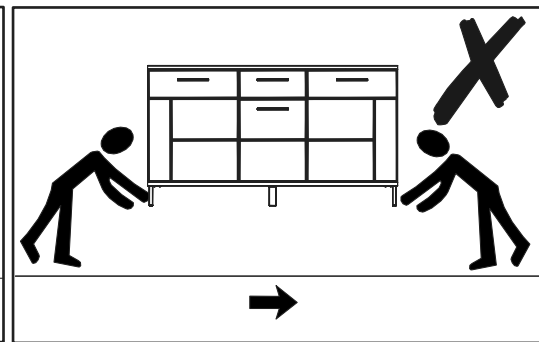
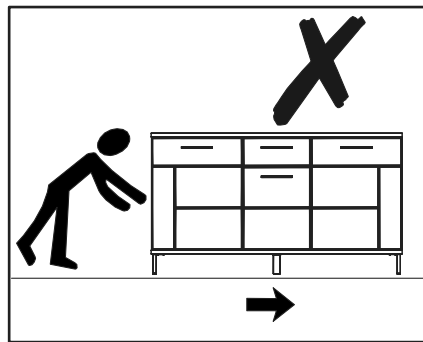
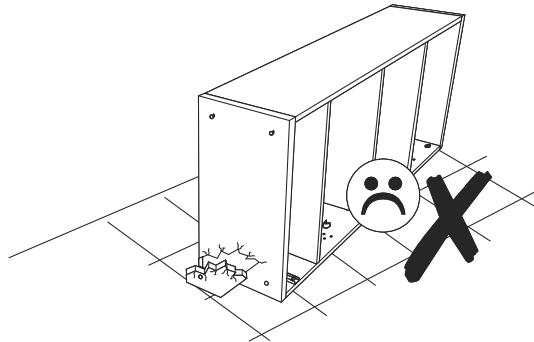
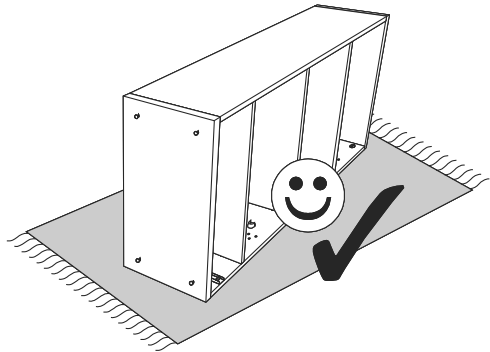
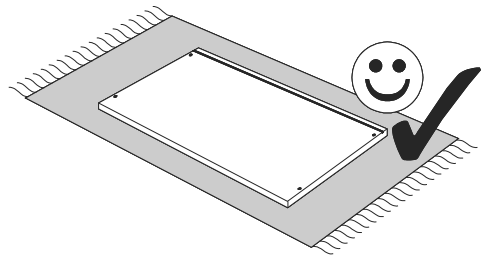

8

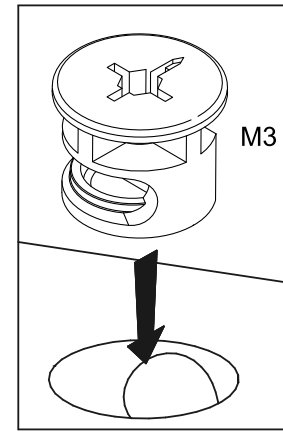
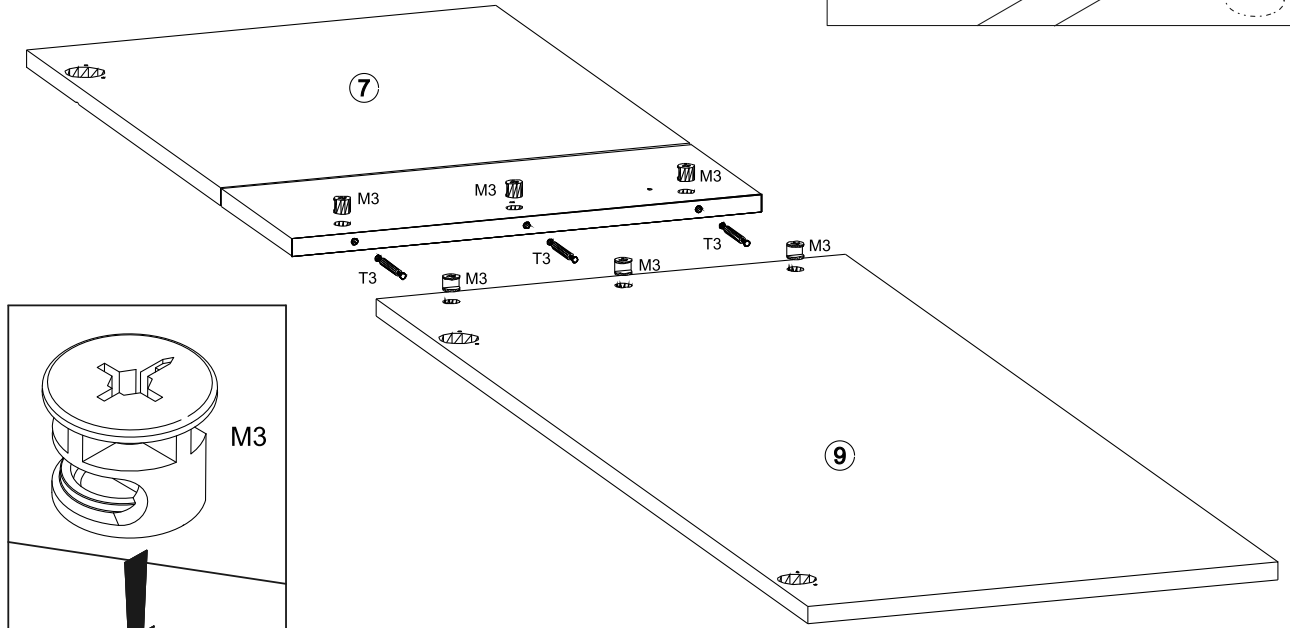
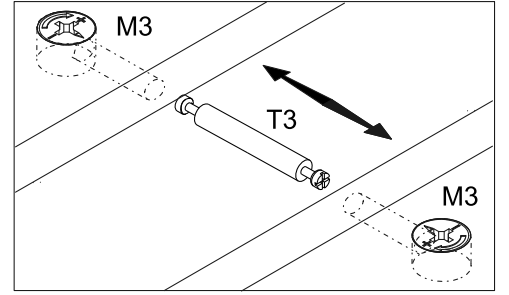

9

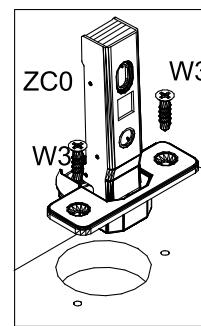
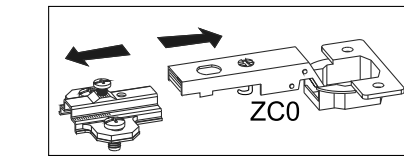
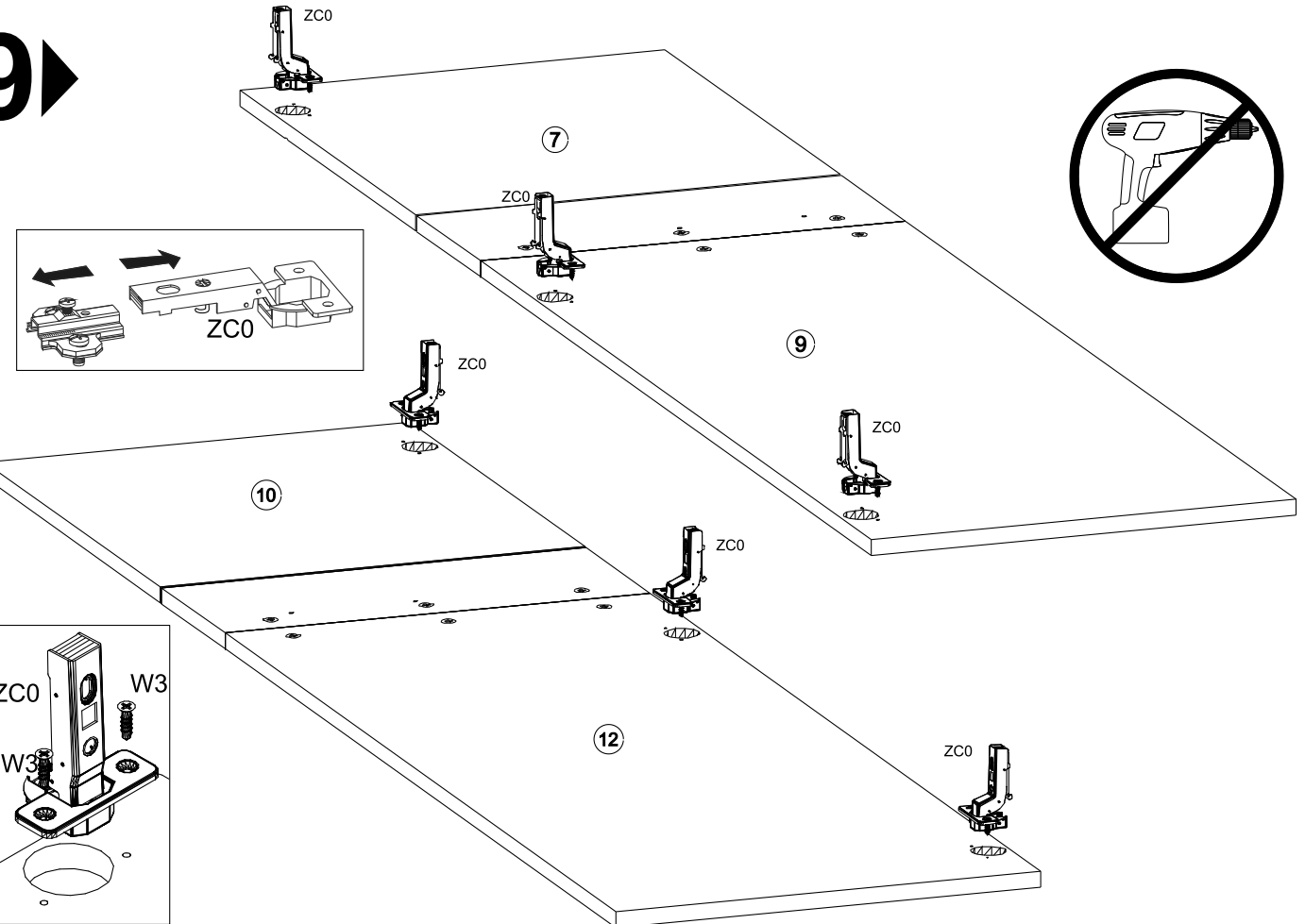

6

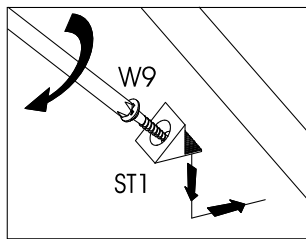
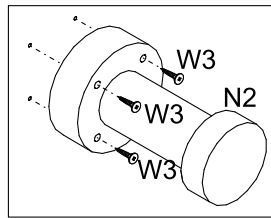
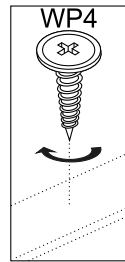
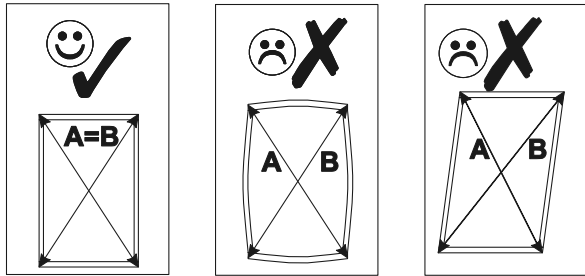
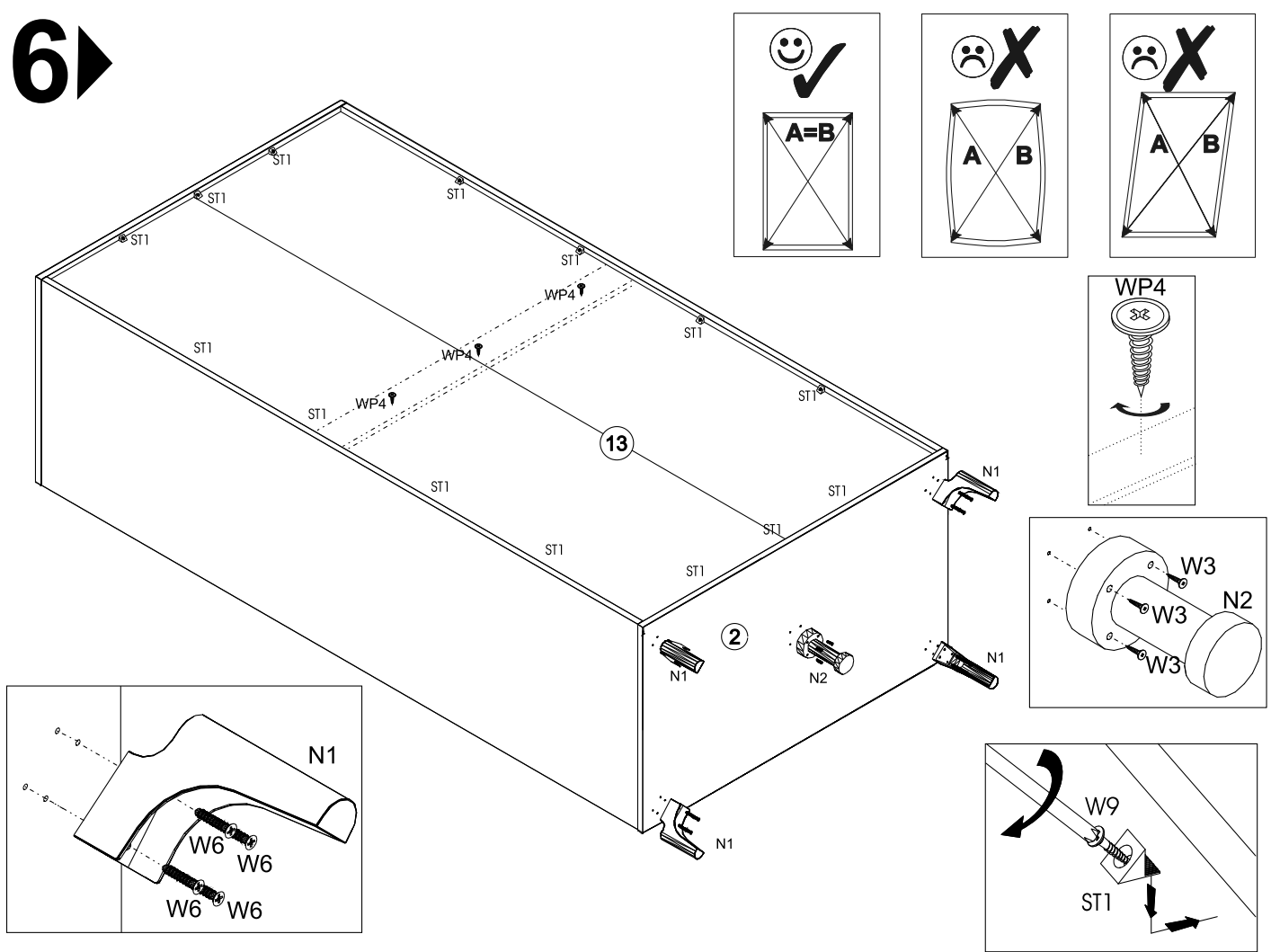

7

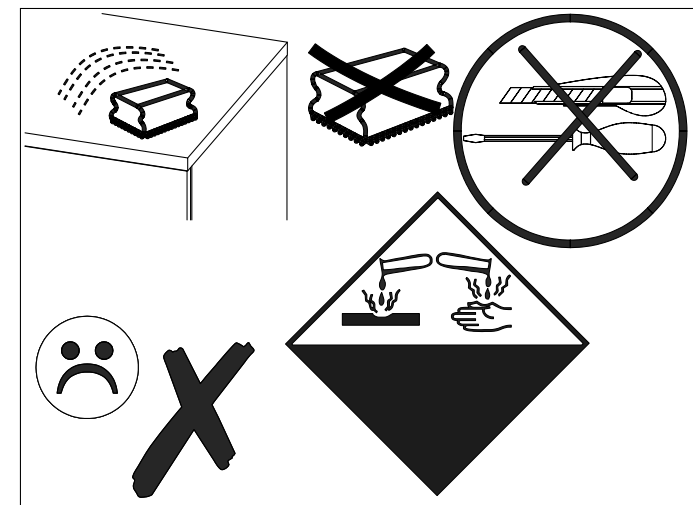
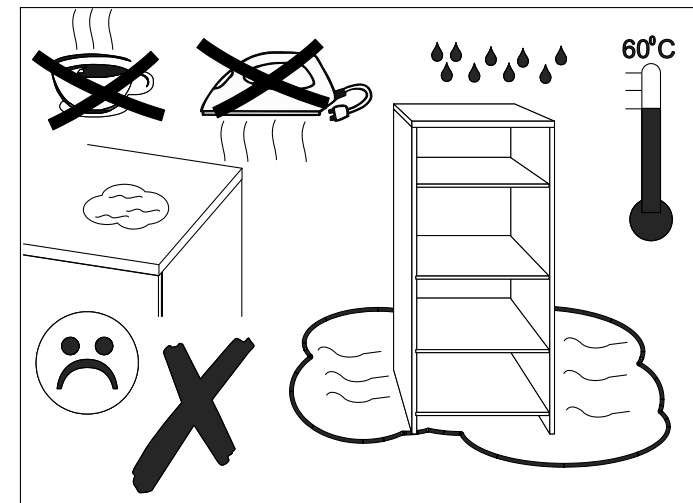
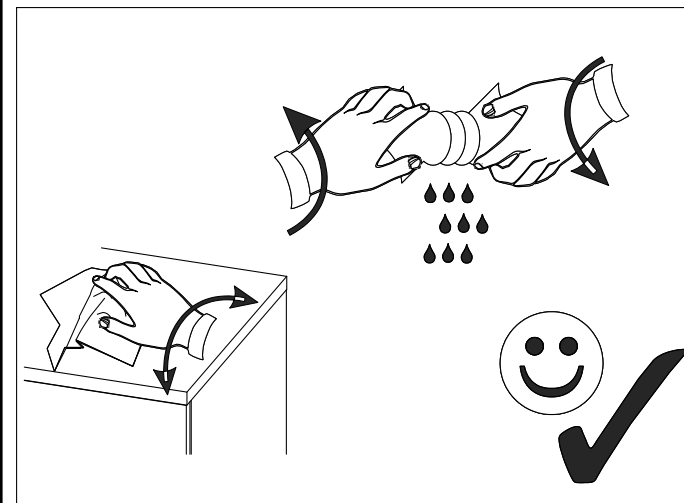
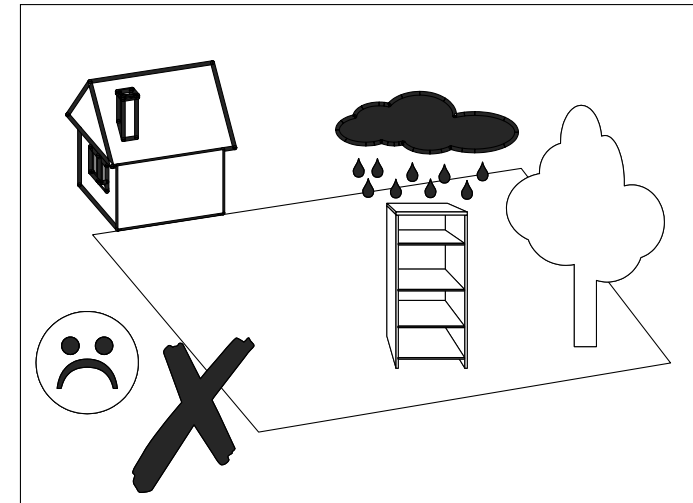
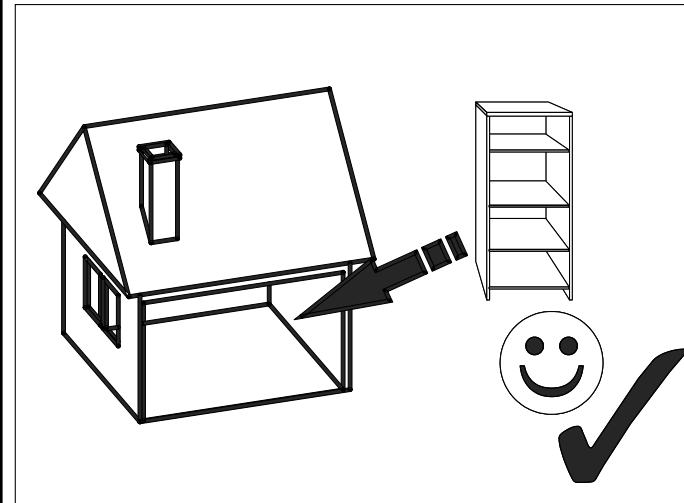
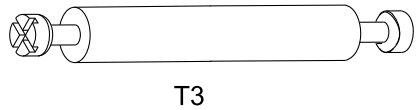
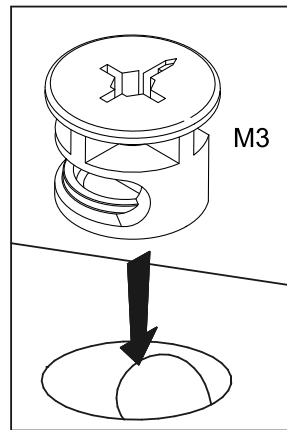
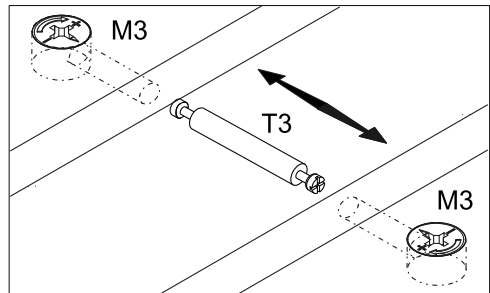
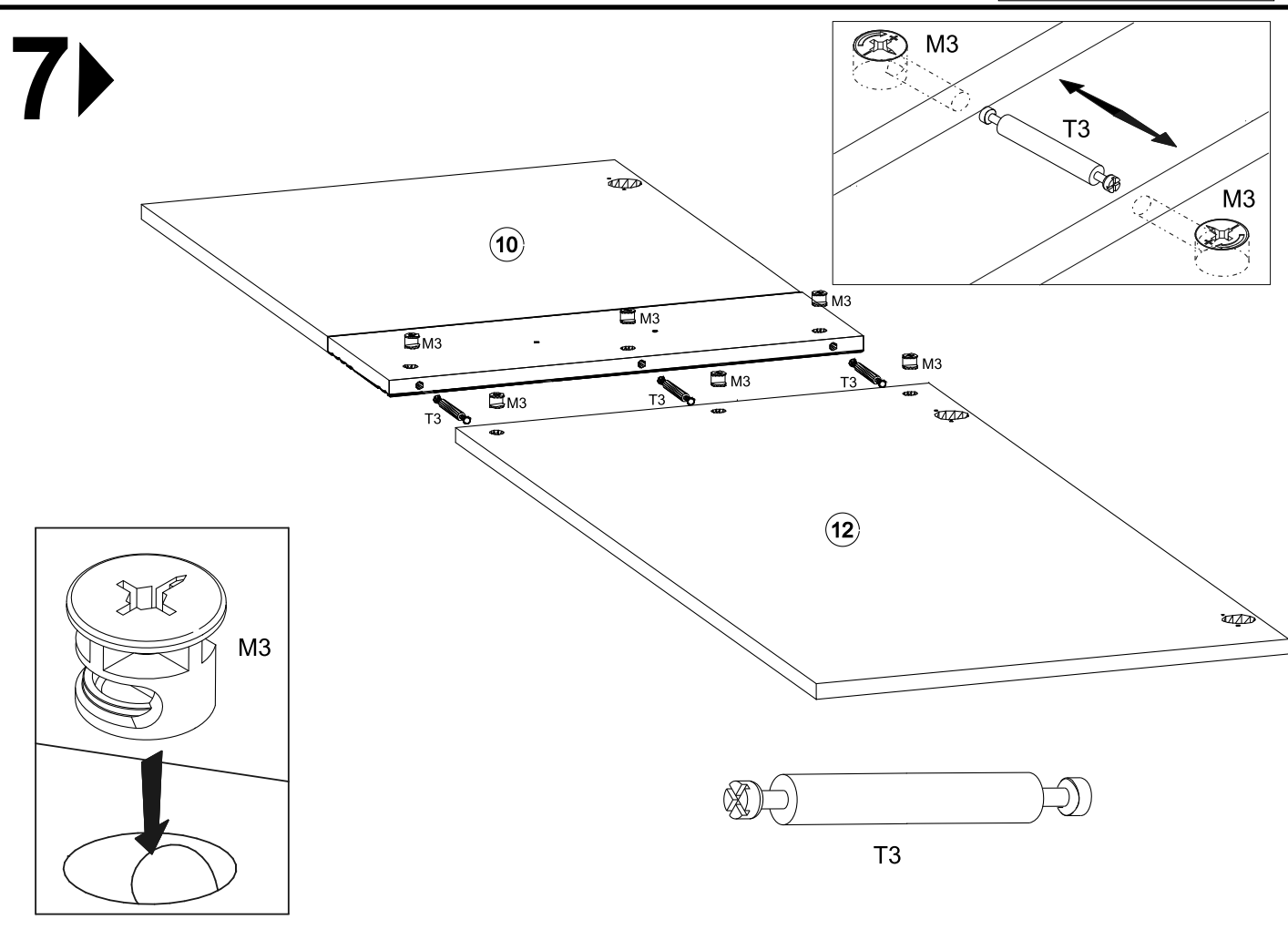

1▶

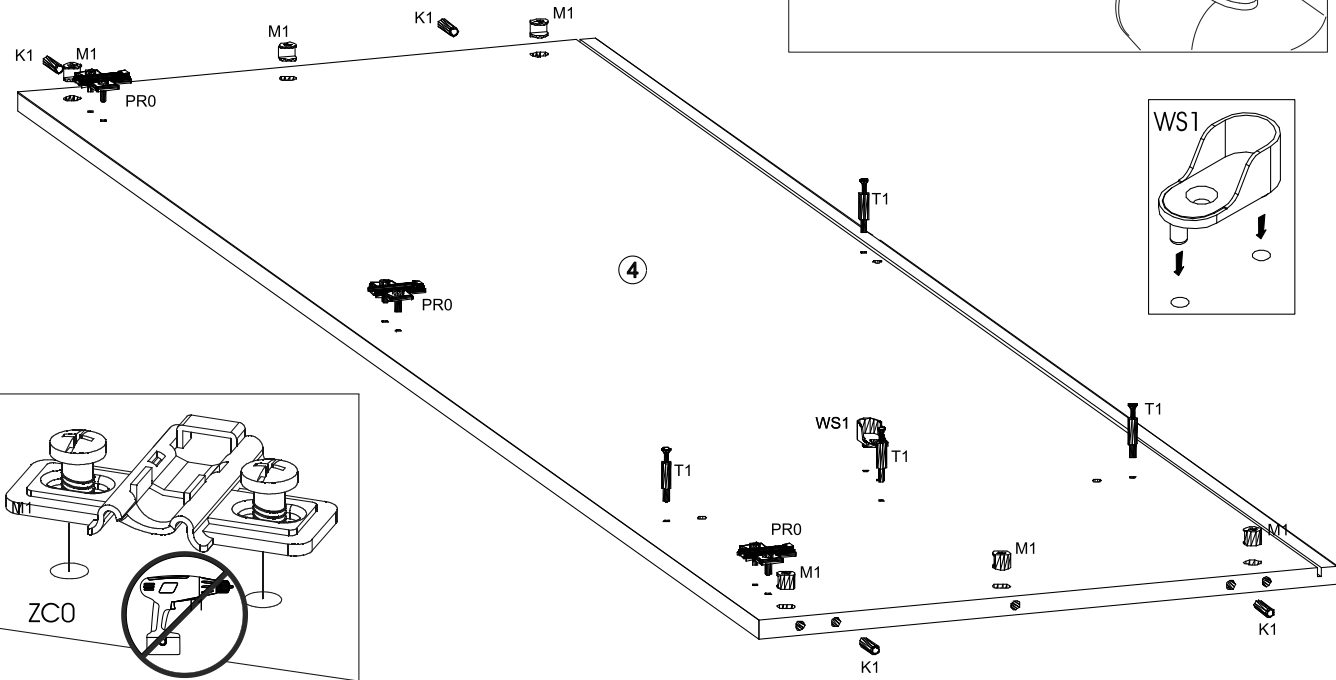
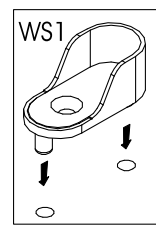
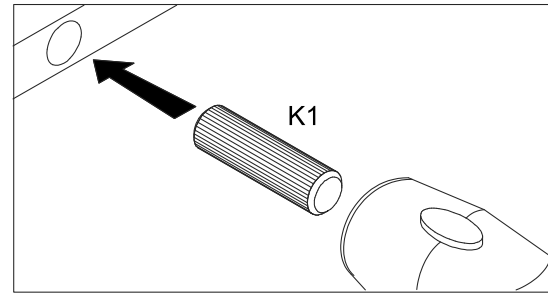
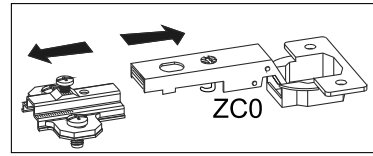
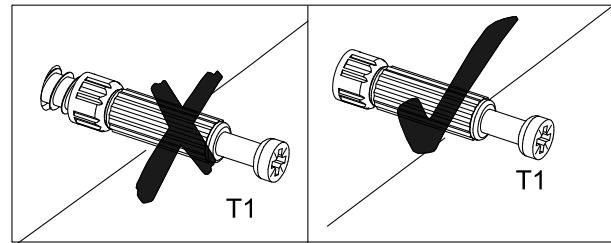
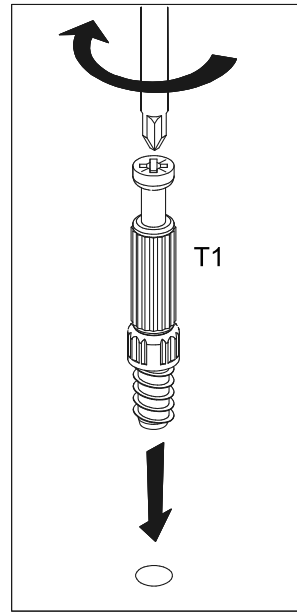
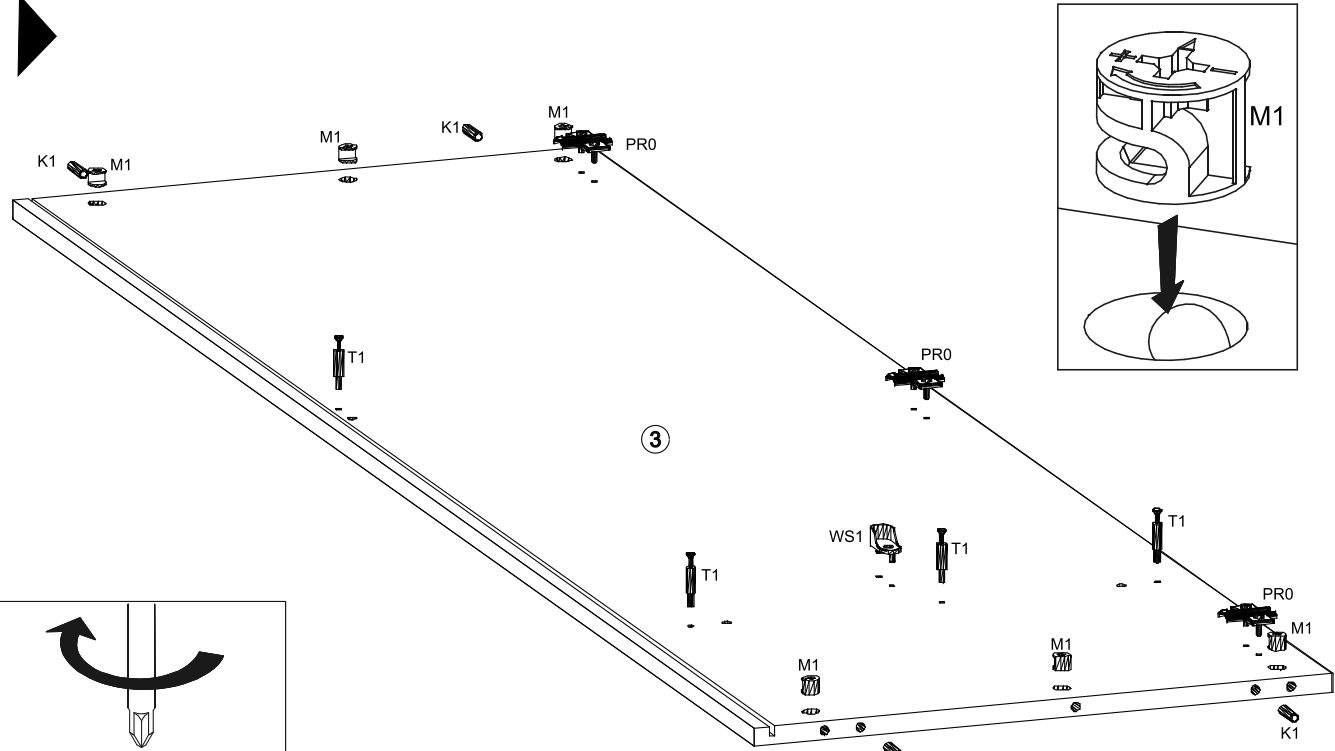

4▶

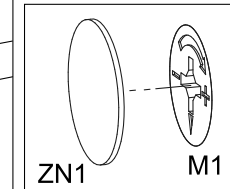
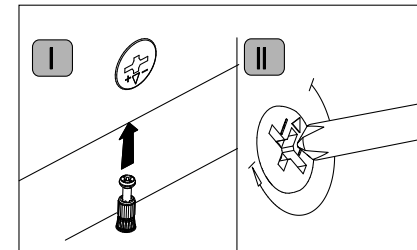
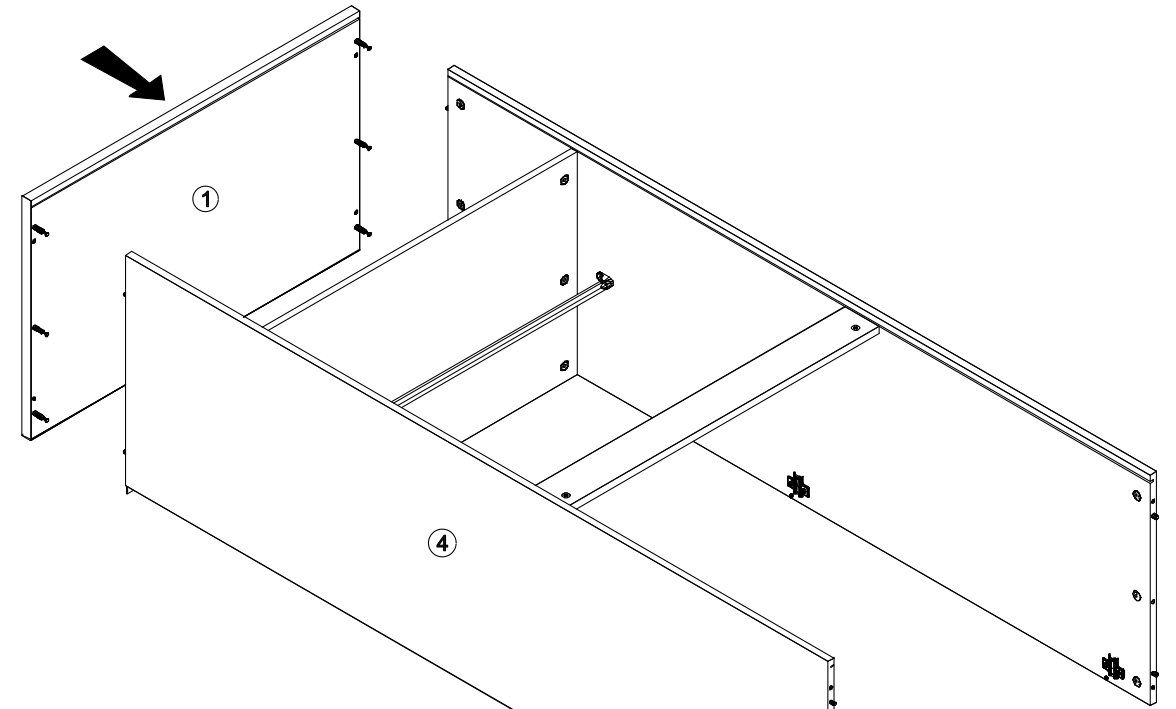

5▶

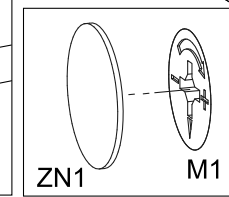
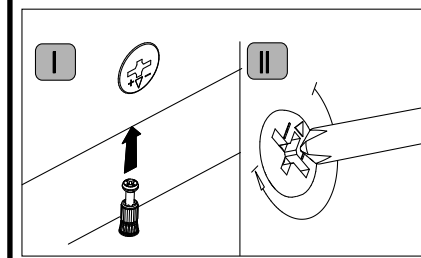
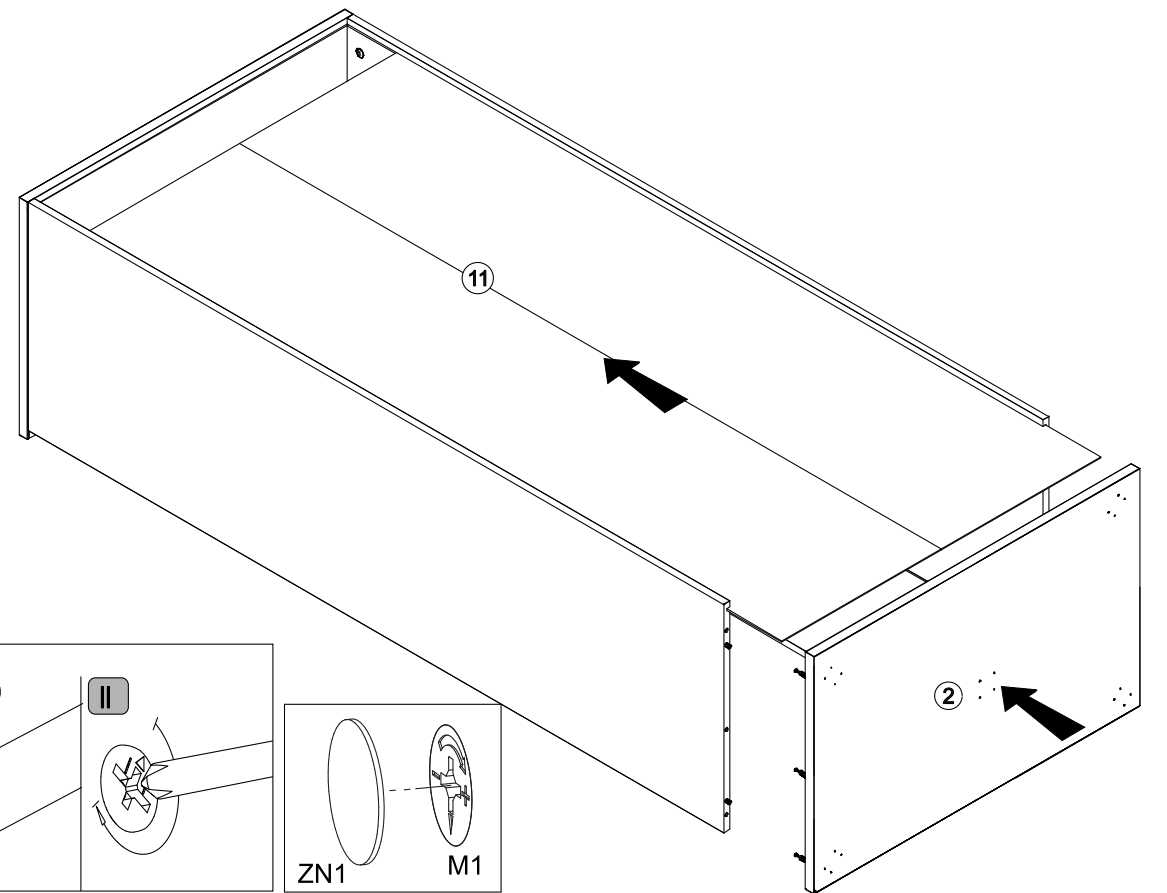

2

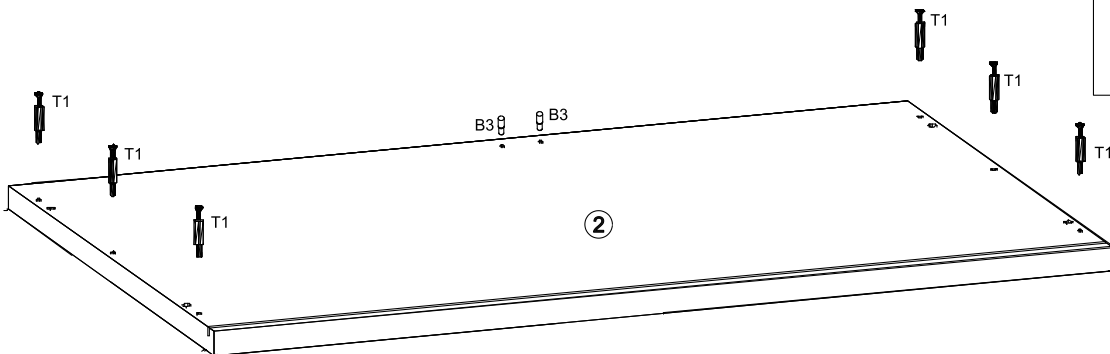
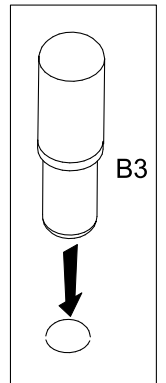
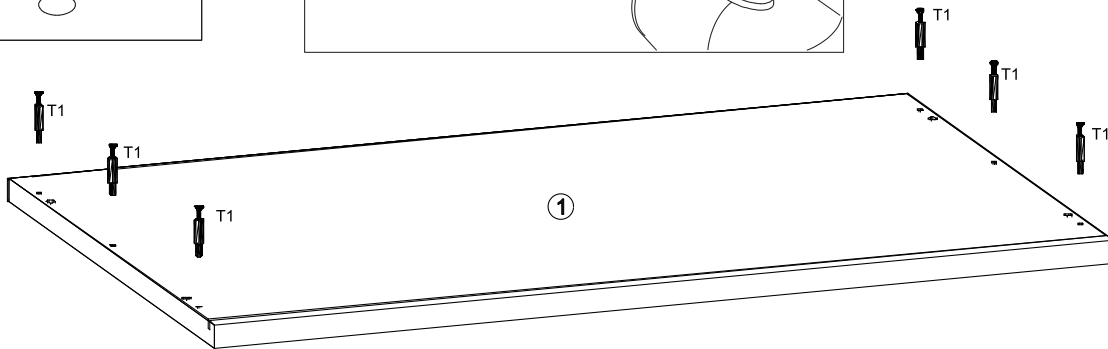
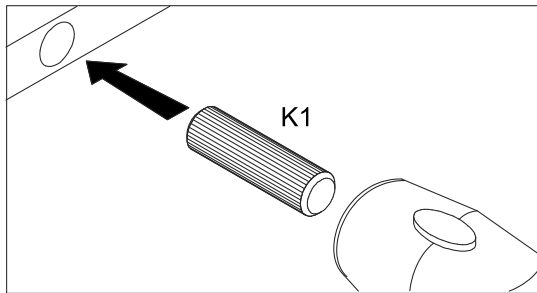
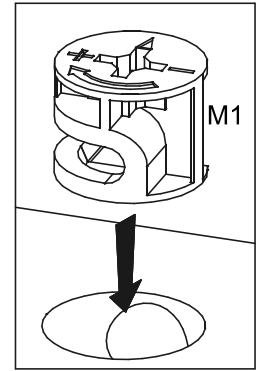
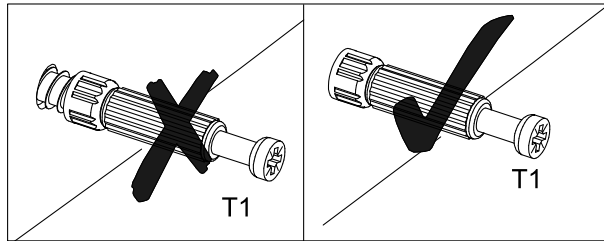
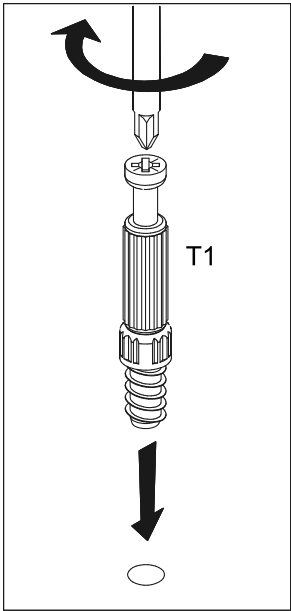
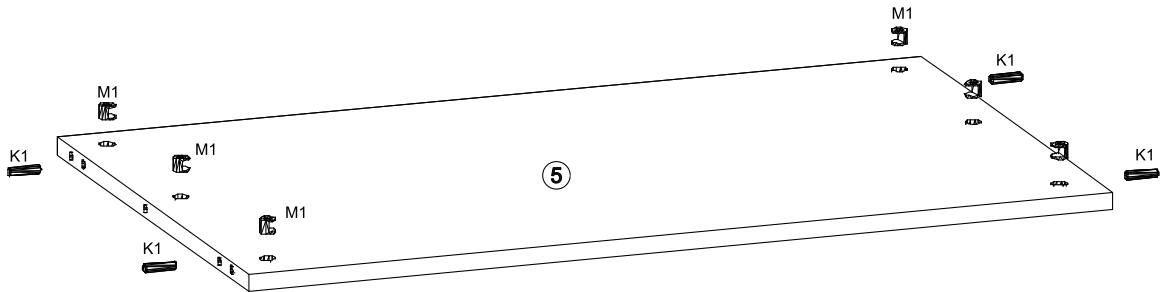
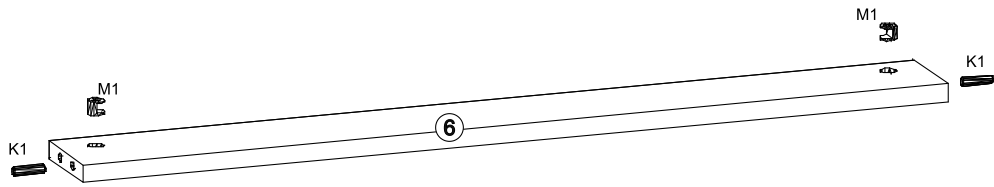

3 ▶

