

COUNTRY

9X--CT K6

1 / 8

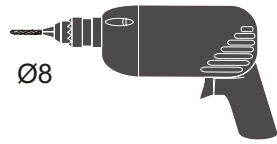
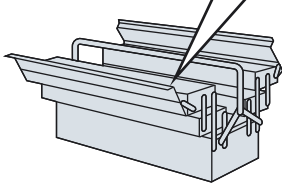
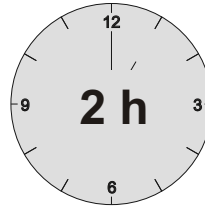
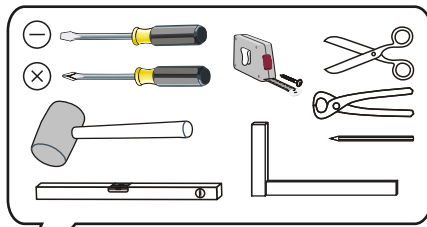
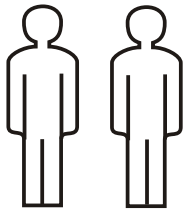

B - 1569mm
H - 893mm
T - 429mm

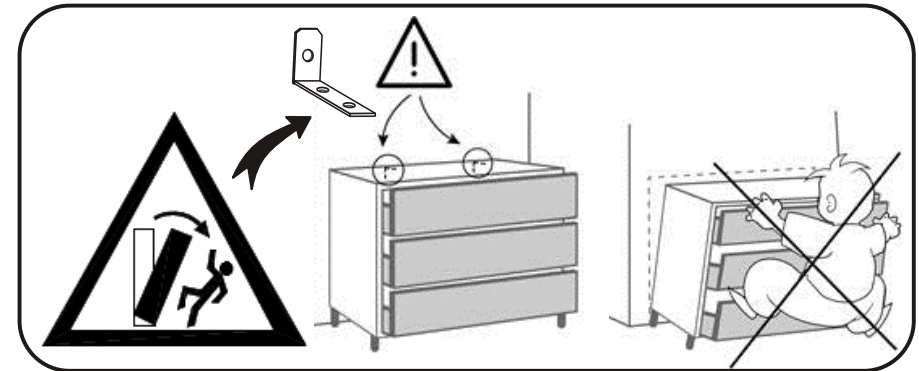
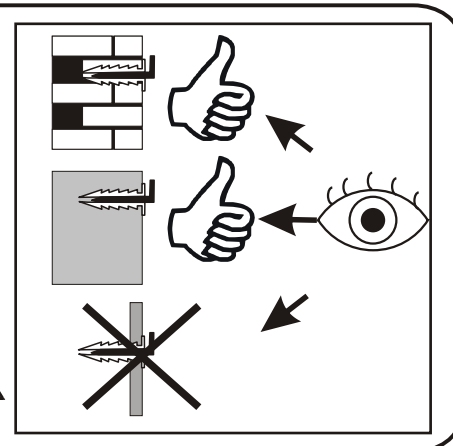
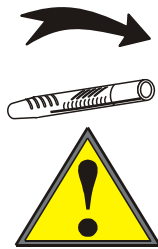
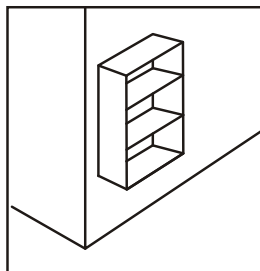
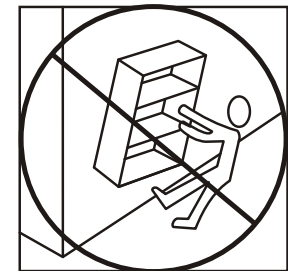
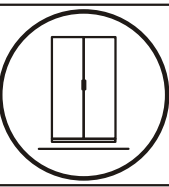
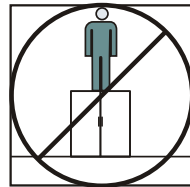
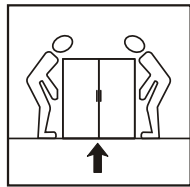
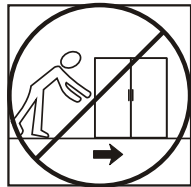
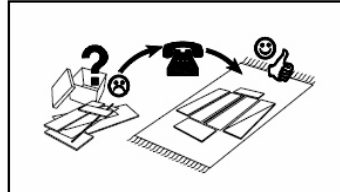
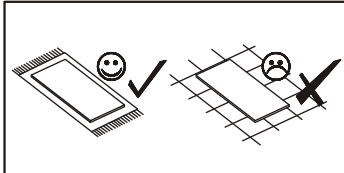
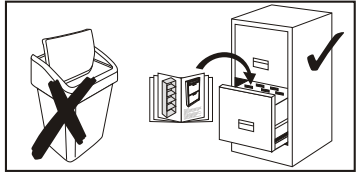
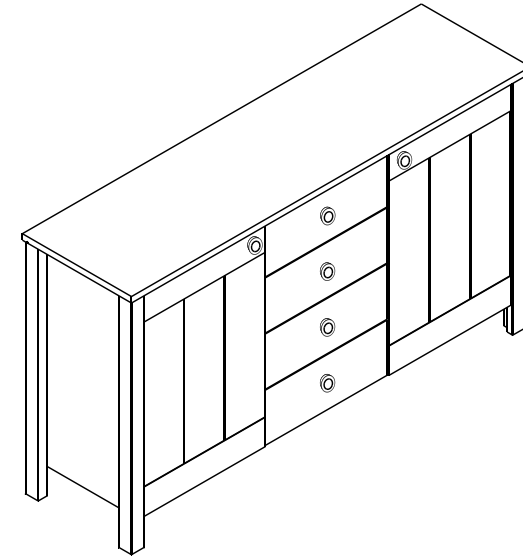

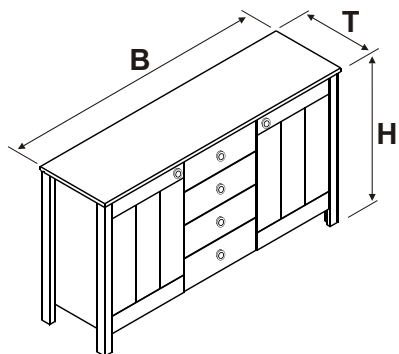

B - 1569mm
H - 893mm
T - 429mm

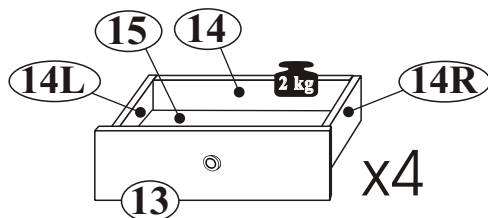
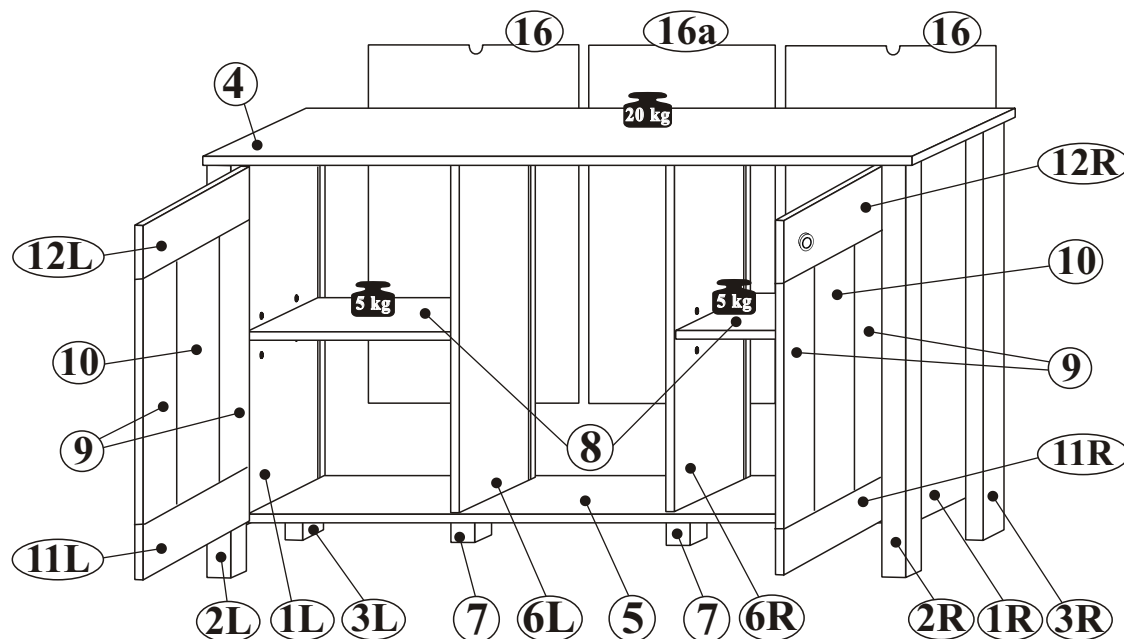

NR 1

(B1) 8x28 x16

(B3) 6x45 x24

(M1) x16+8

(T1) x16+8

(K9) 7x35 x16

(K1) 7x50 mm x2

NR 2

(C14) mm x12

(J23) x28

(W1) x8

(F15) x6

(G7) S4 x1

NR 3

(Y1) Kr15 x4

(D7) H4 x4

(S8) 4x13 x8

(E3) 6,3x13 x8

NR 5

(U61) x6

(A14) M4x23 x6

NR 6

(J11) x2

(P13) 3,5x13 mm x4

NR 4

(R22) L-350 mm x4L/4R

(E2) 6x11 x24

(P3) 3x13mm x16

(S3) 3,5x13 x8







(M2) 12x10mm x8

(T2) 5x35mm x8

(P5) 4x30 x16



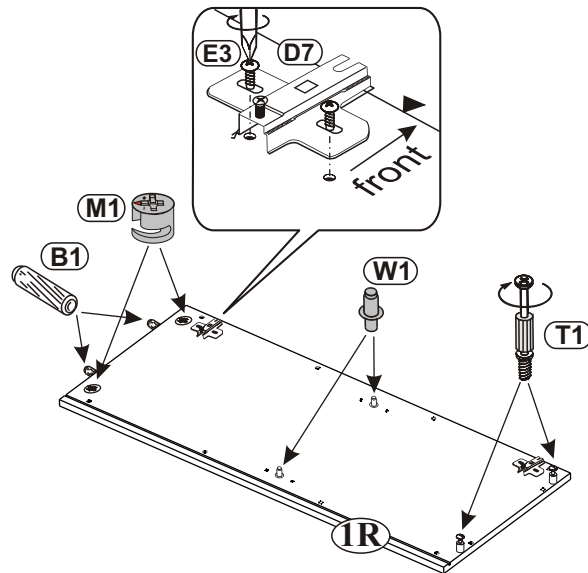
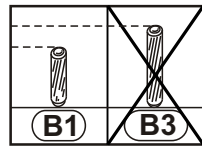
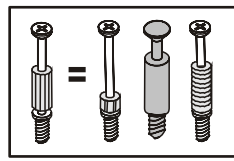
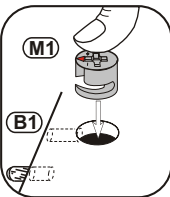
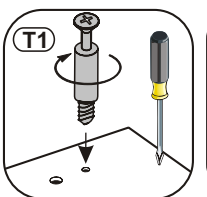
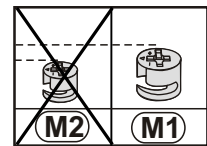
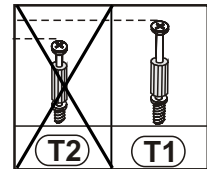
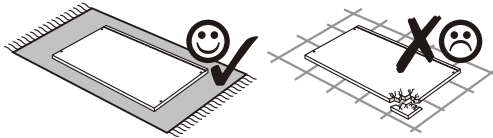
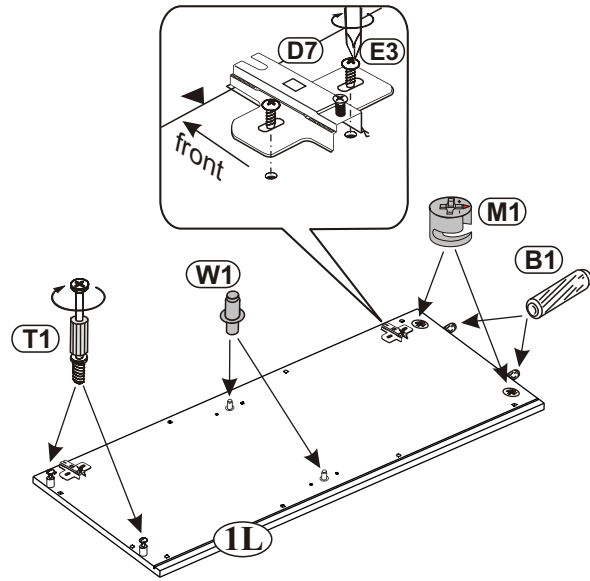

1

- B1**  8x28 x4
- M1**  x4
- T1**  x4
- W1**  x4
- D7**  x4
H4
- E3**  6,3x13 x8



2

- K9**  7x35 X16
- G7**  S4 x1
- F15**  x6

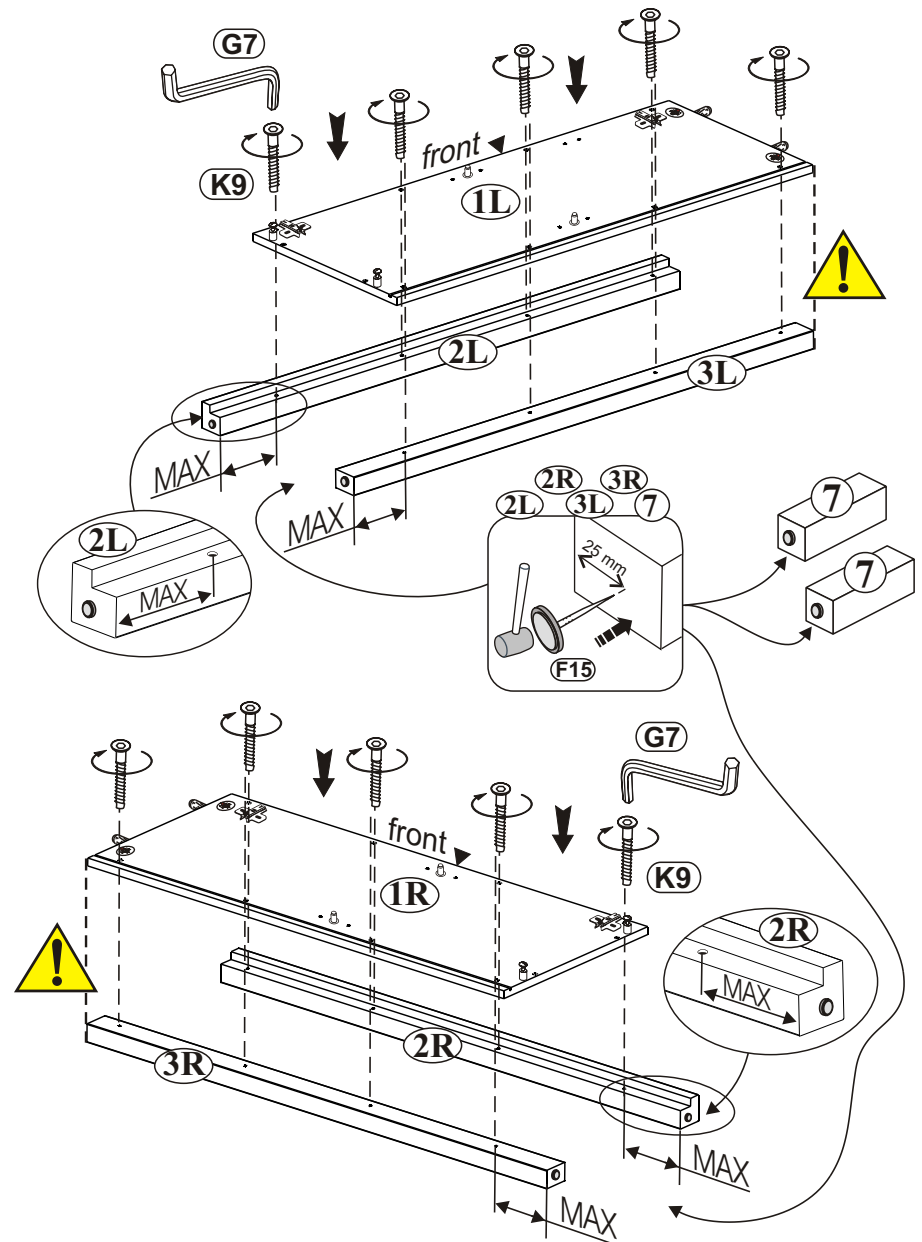





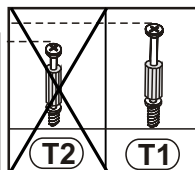
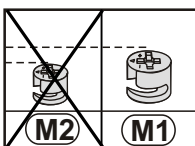
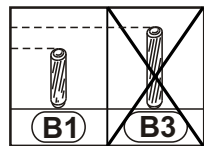
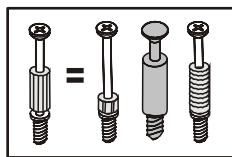
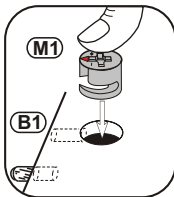
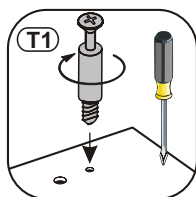
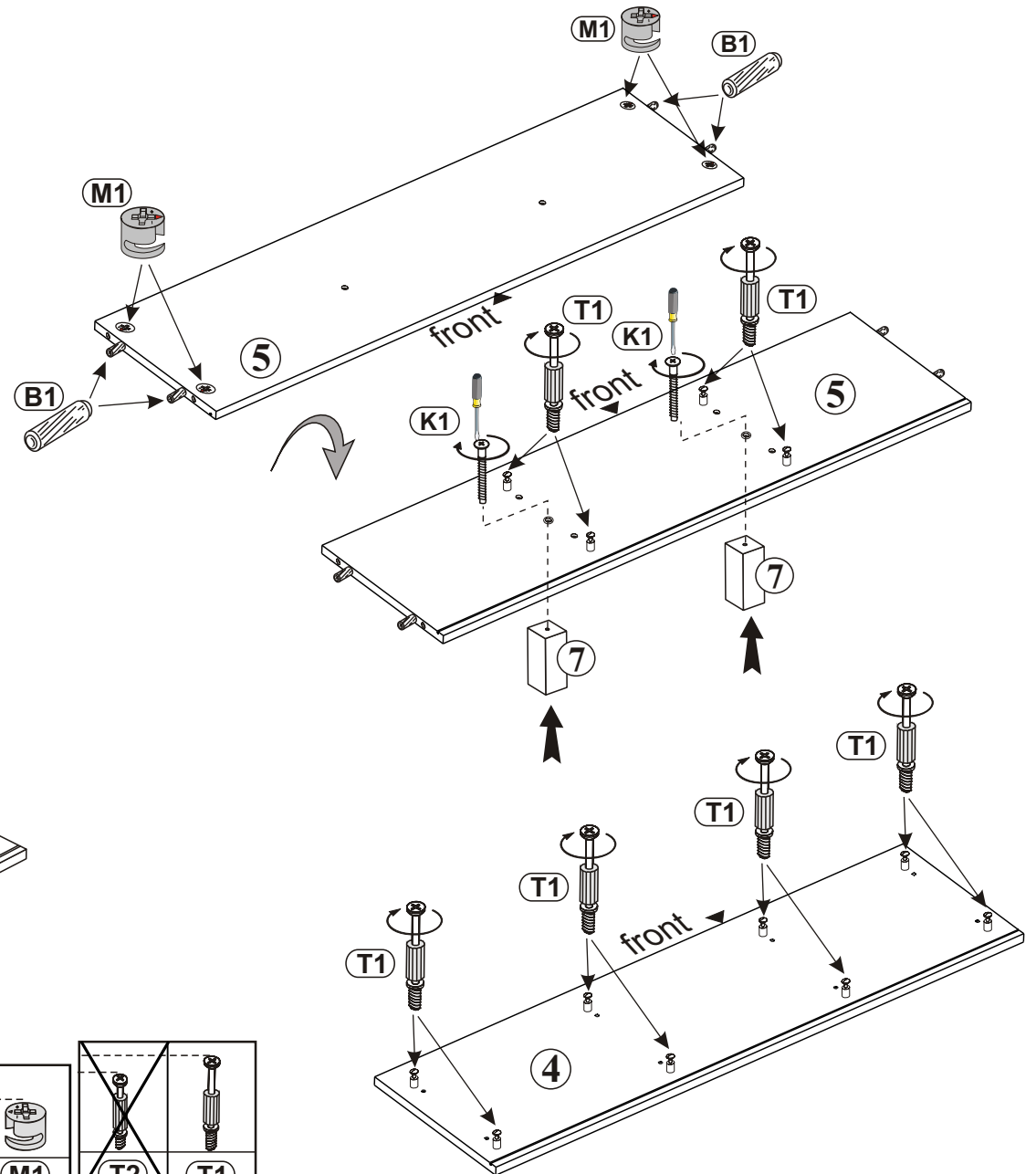
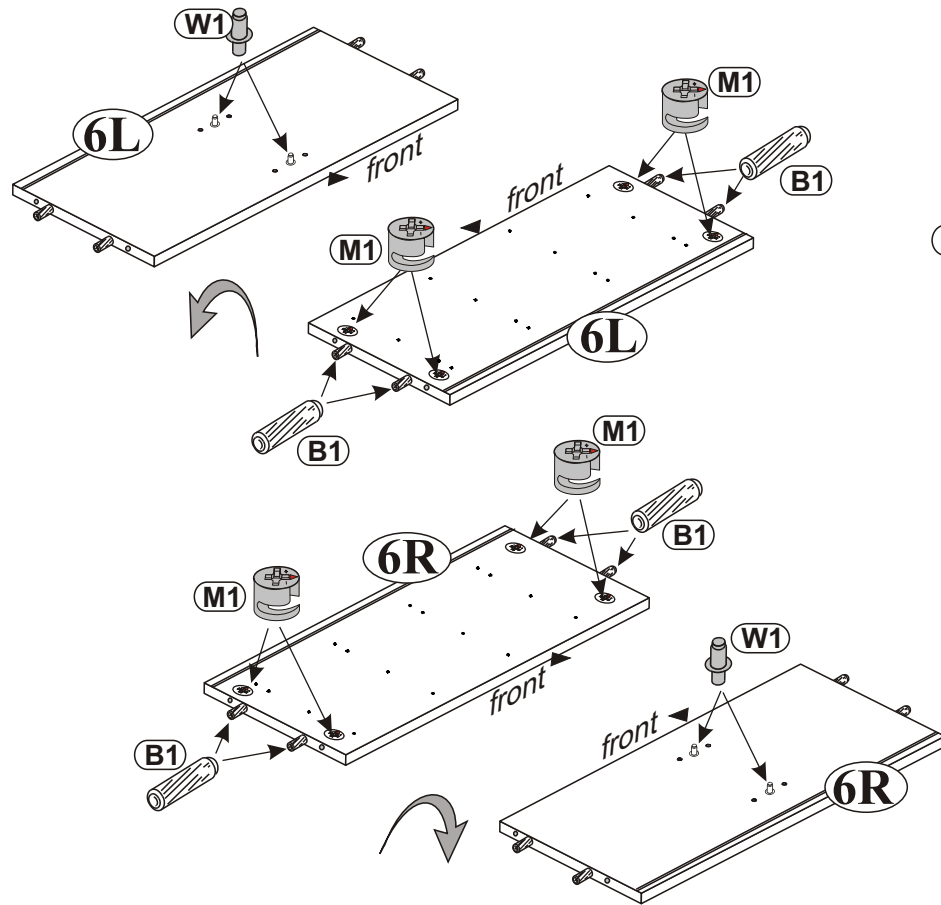

3

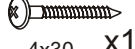
B1 8x28 x12	T1 x12	K1 7x50 mm x2
M1 x12	W1 x4	



4

R22 L-350 mm  x4L/4R	P5 4x30 x16 	U61  x4
P3 3x13mm x16 	M2 12x10mm x8 	A14 M4x23 x4 
T2 5x35mm x8 	J23  x8	

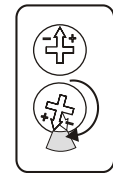
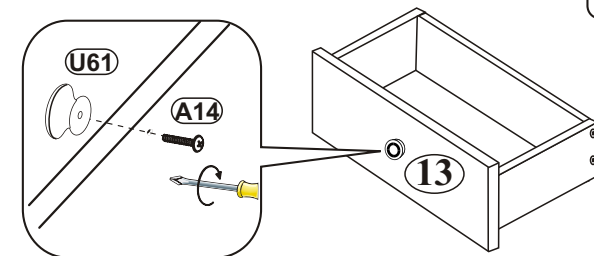
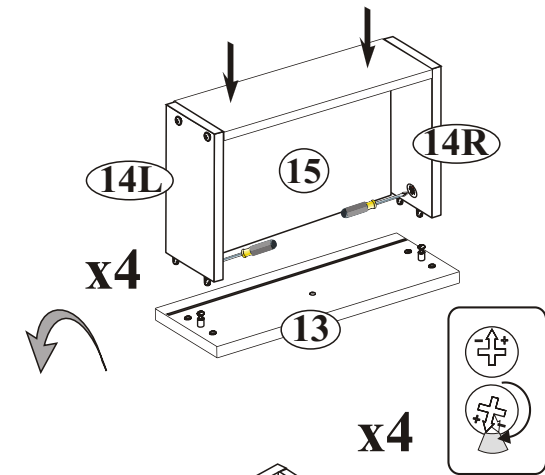
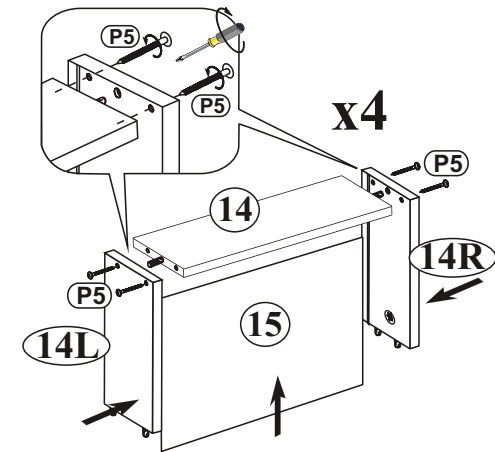
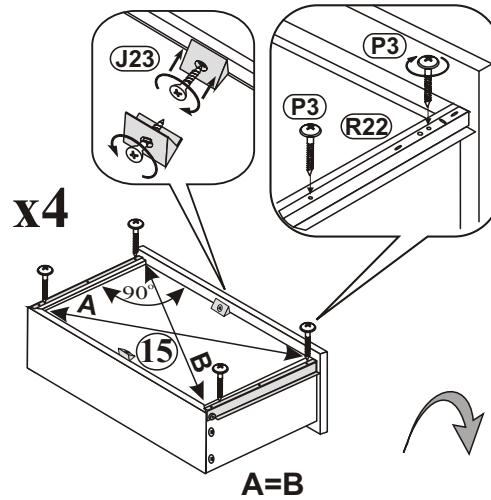
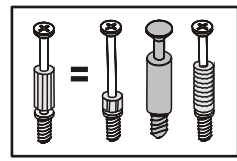
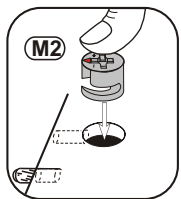
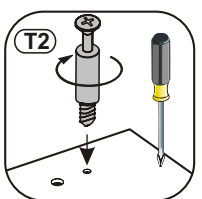
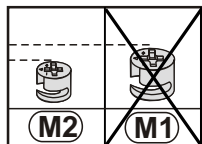
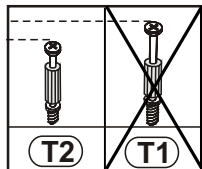
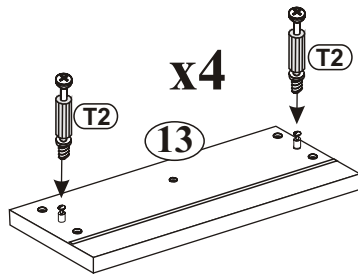
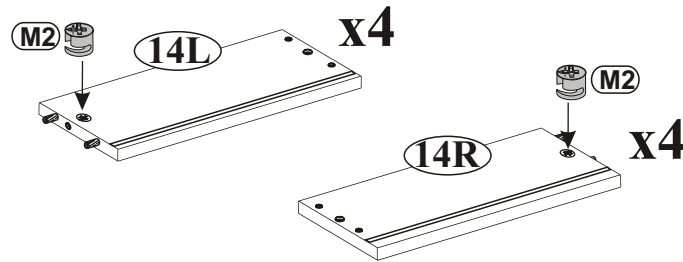

5

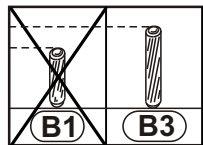
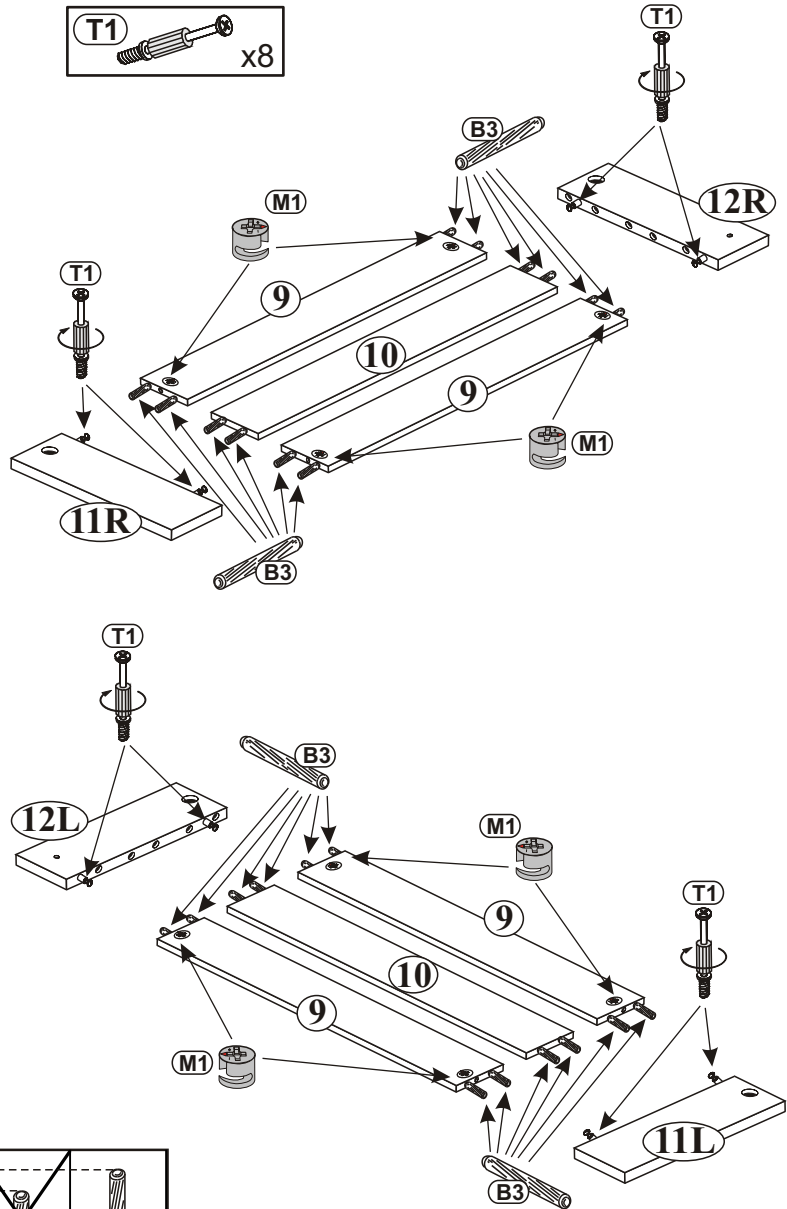
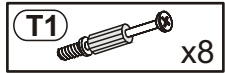
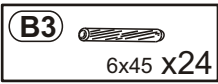
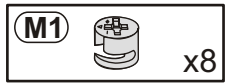

6

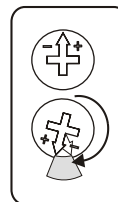
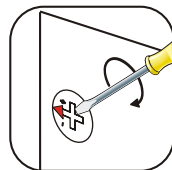
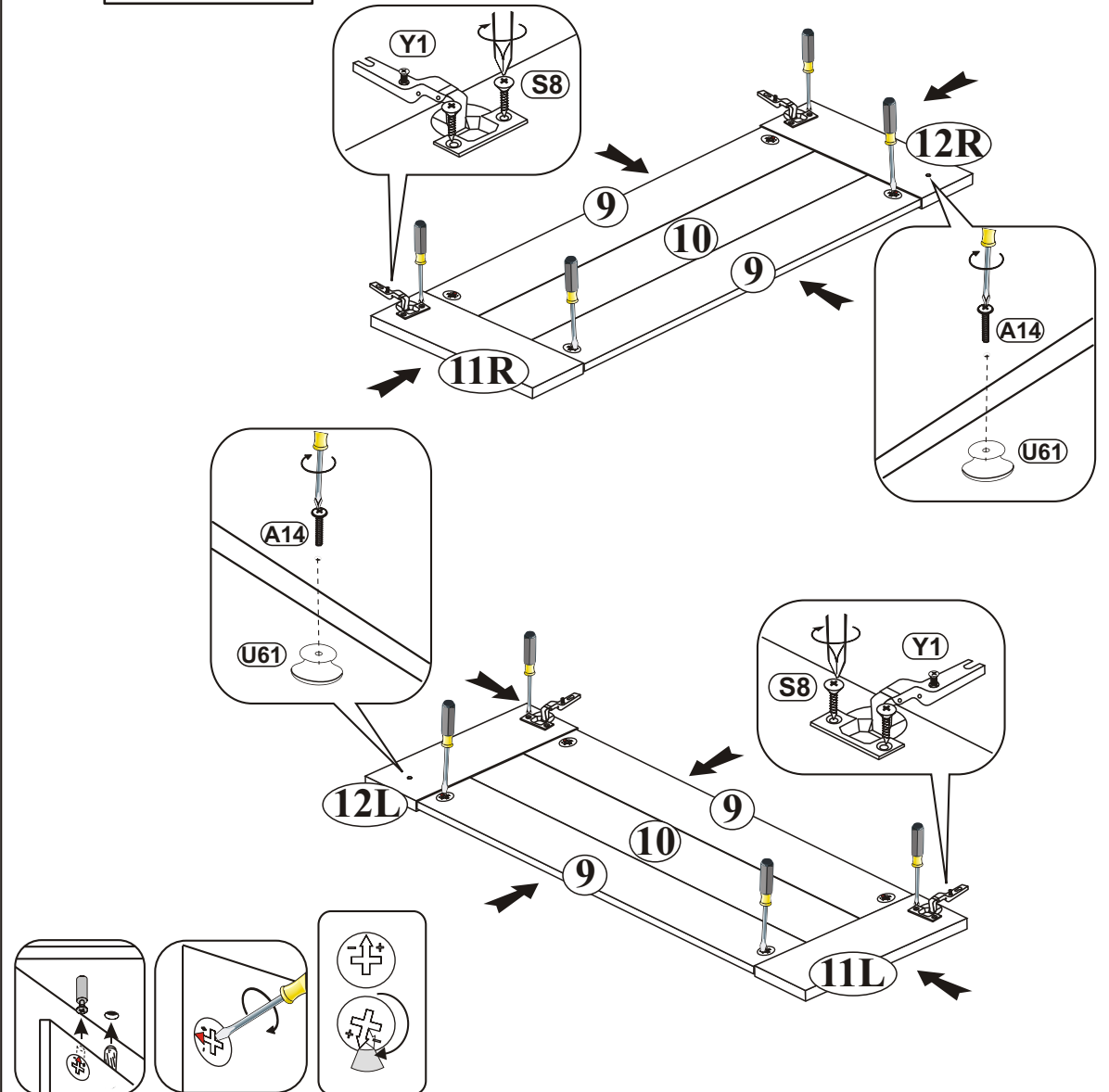
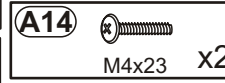
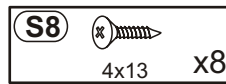
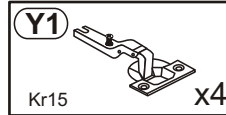

7

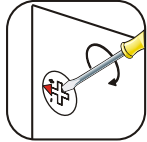
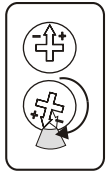
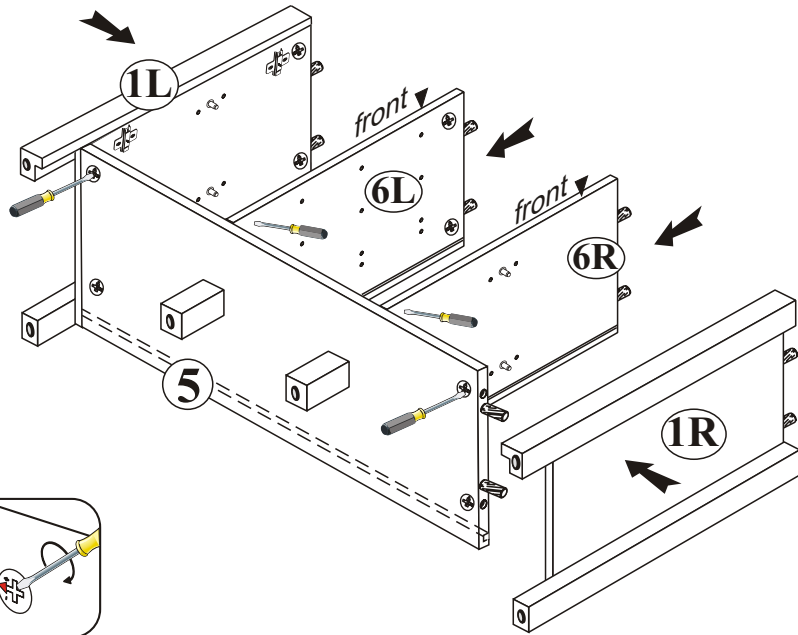

8

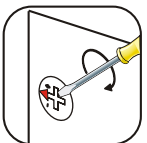
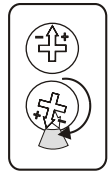
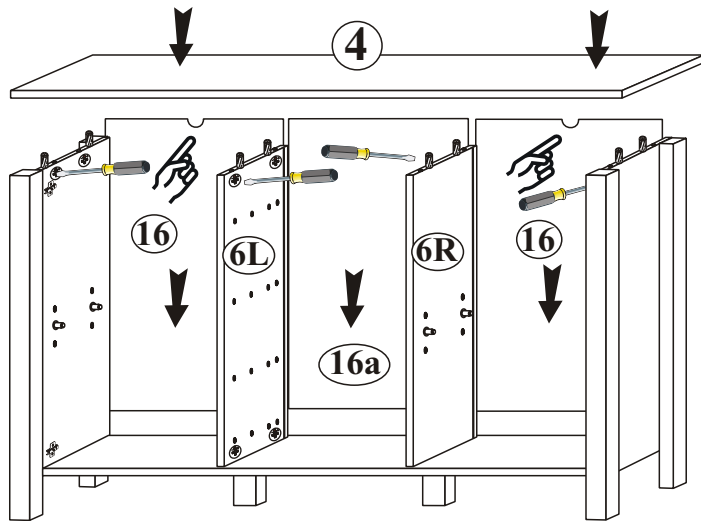

9

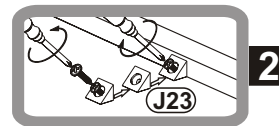
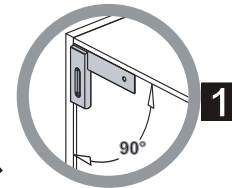
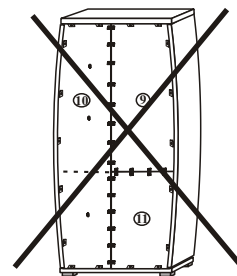
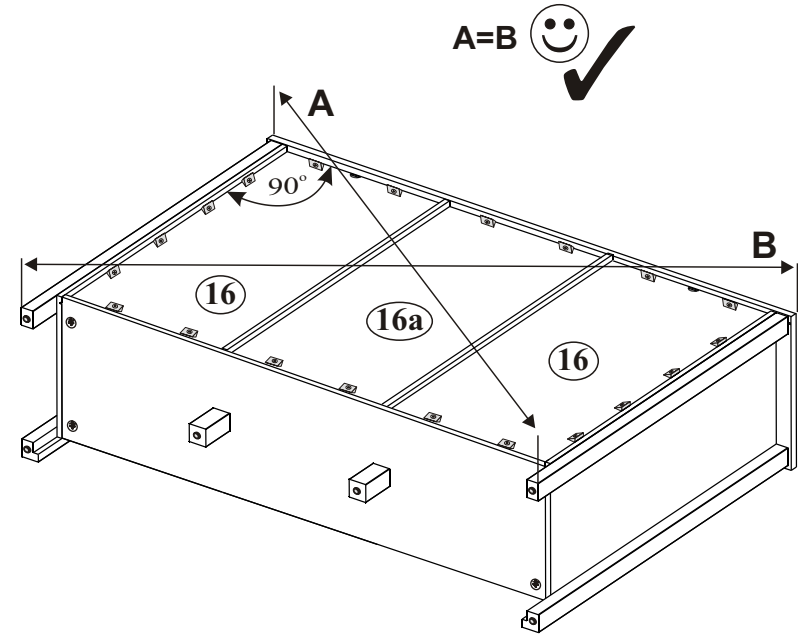
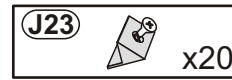

10

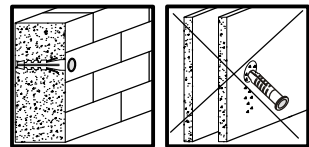
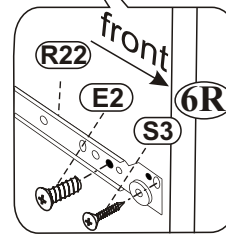
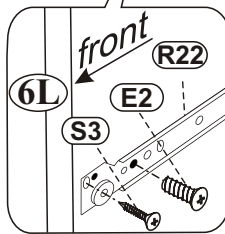
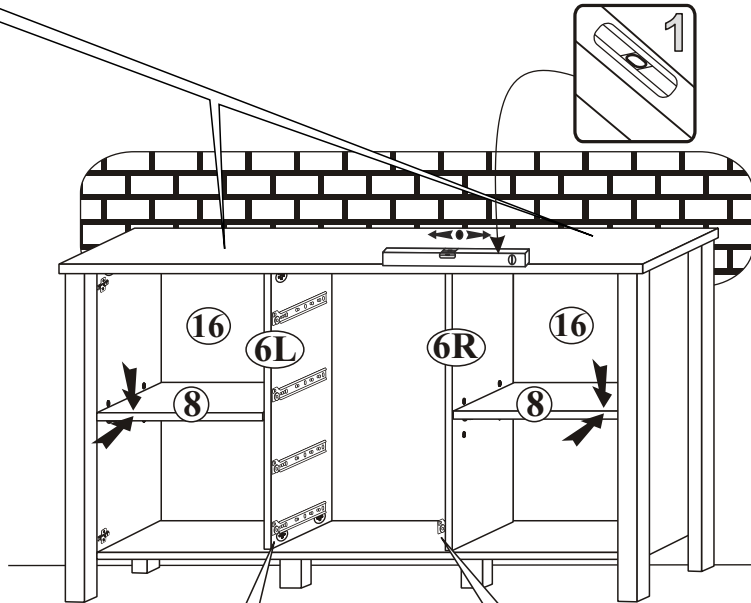
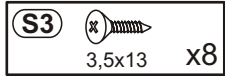
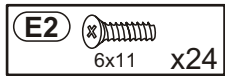
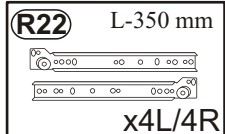
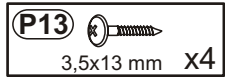
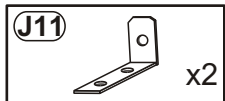
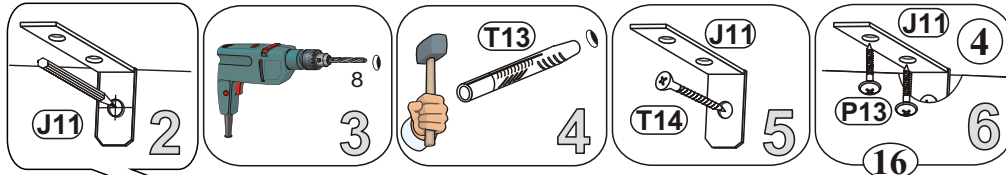

11

