

COUNTRY

9X--CT 02

1 / 8

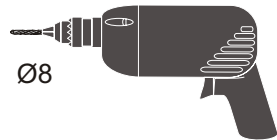
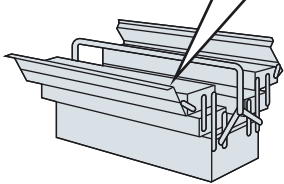
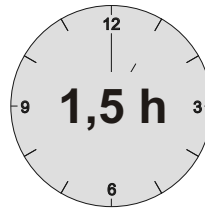
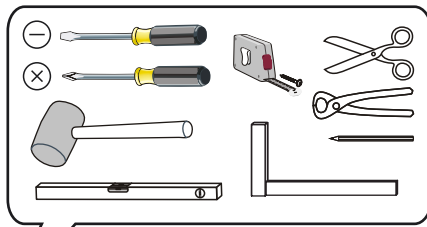
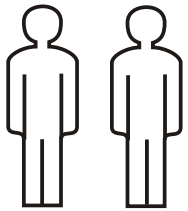

B - 604mm  
H - 1912mm  
T - 429mm

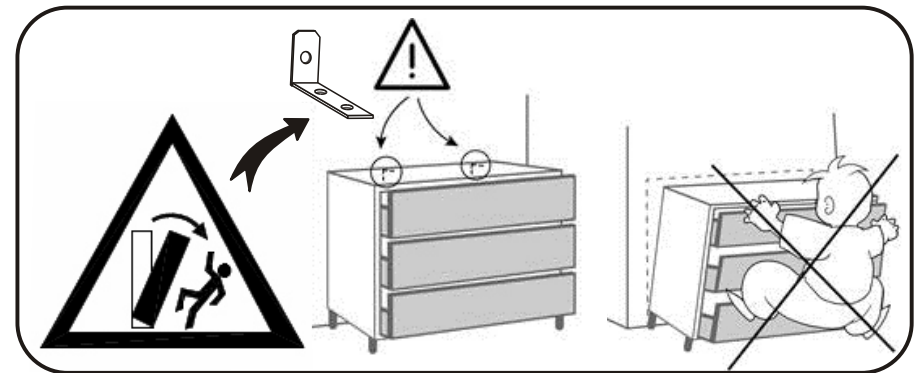
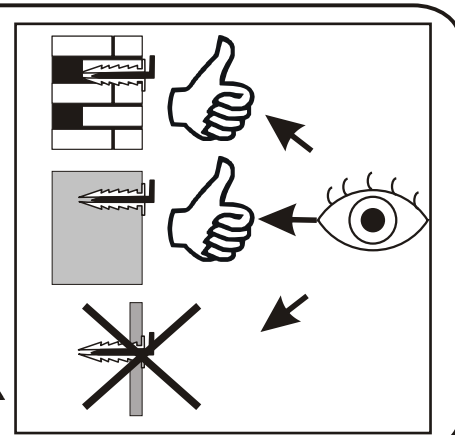
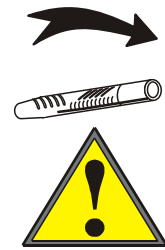
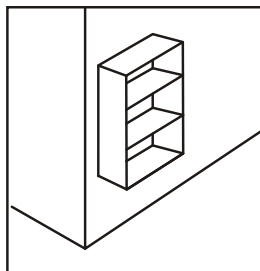
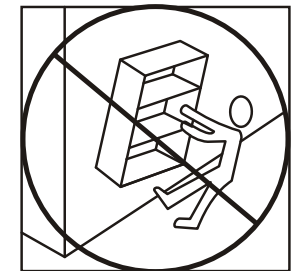
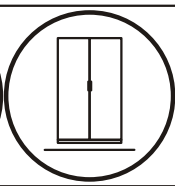
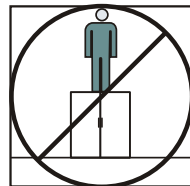
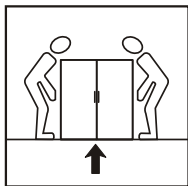
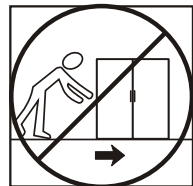
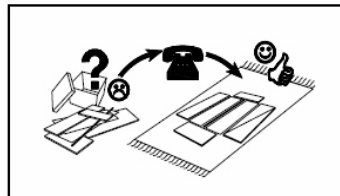
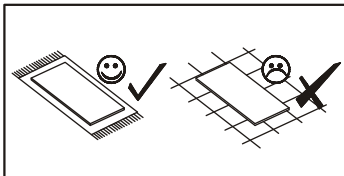
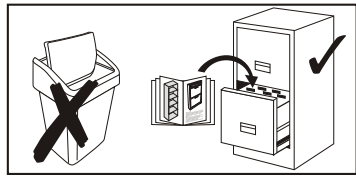
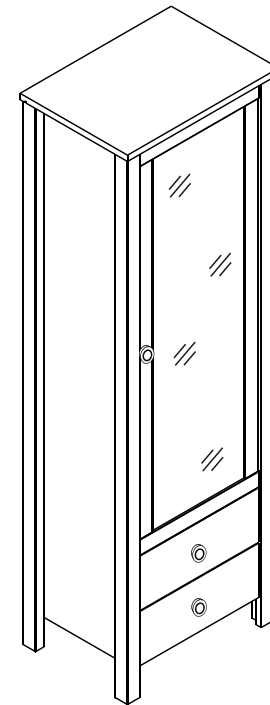

B - 604mm  
 H - 1912mm  
 T - 429mm

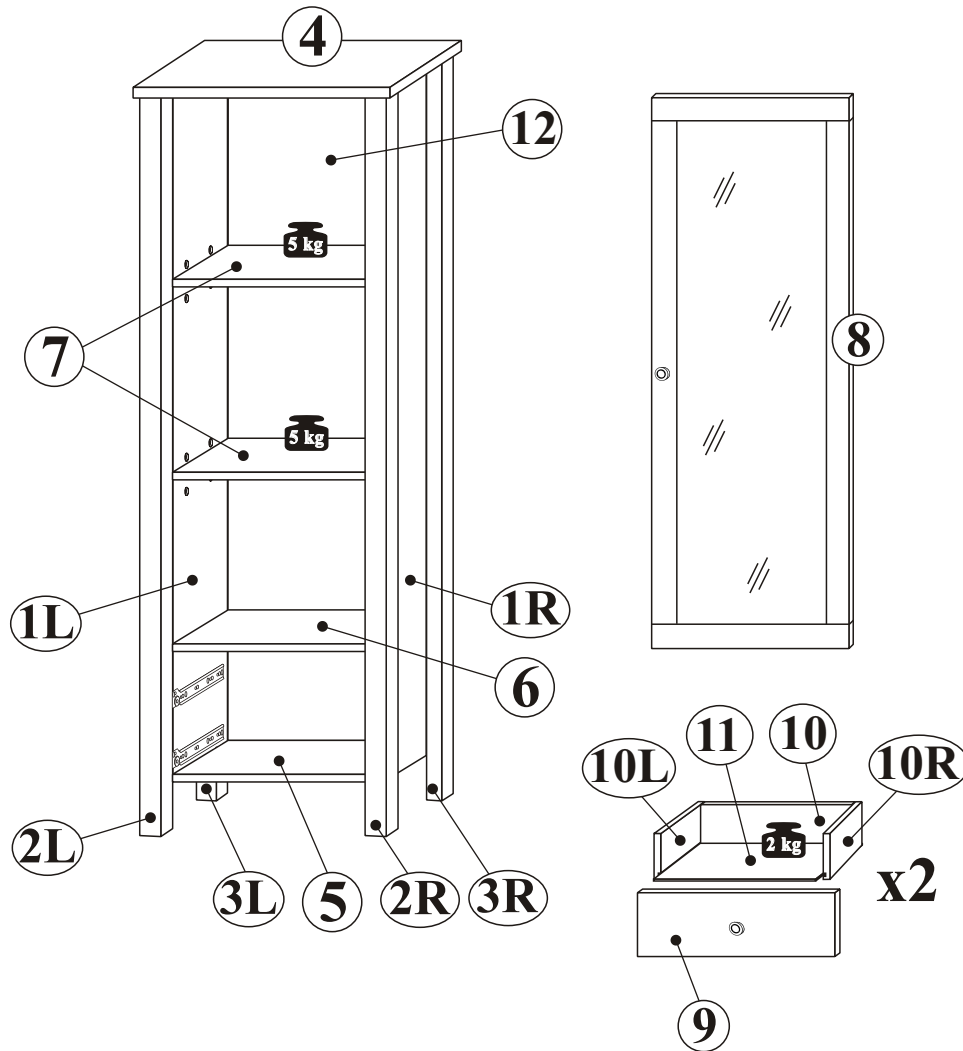
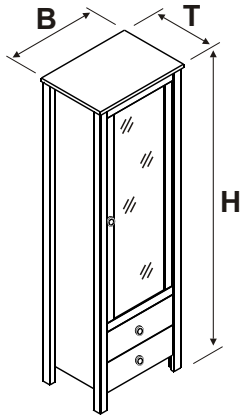





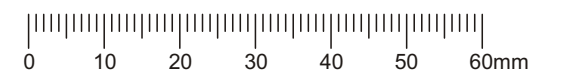

- NR 1**
- B1** 8x28 x12
  - M1** x12
  - T1** x12
  - K9** 7x35 x20
- NR 2**
- C14** mm x4
  - J23** x24
  - W1** x8
  - S4** 3,0x20 x3
  - F15** x4
  - G7** S4 x1

- NR 3**
- R22** L-350 mm x2L/2R
  - E2** 6x11 x12
  - P3** 3x13mm x8
  - S3** 3,5x13 x4
  - M2** 12x10mm x4
  - T2** 5x35mm x4
  - P5** 4x30 x8

- NR 4**
- Y1** Kr15 x4
  - D7** H4 x4
  - S8** 4x13 x8
  - E3** 6,3x13 x8
- NR 5**
- U61** x3
  - A14** M4x23 x3
- NR 6**
- J11** x1
  - P13** 3,5x13 mm x2



1

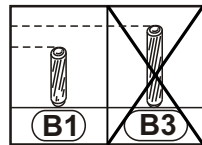
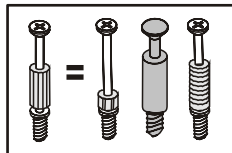
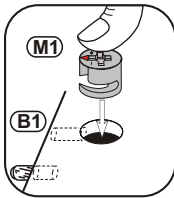
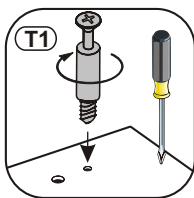
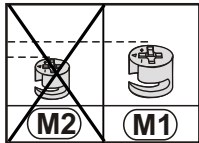
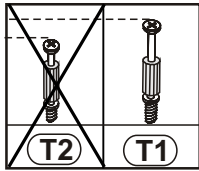
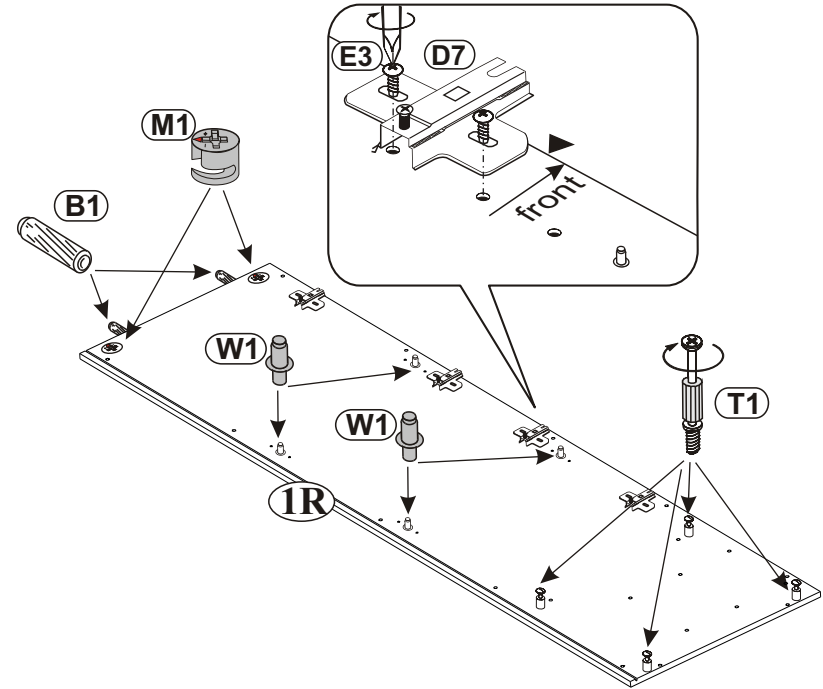
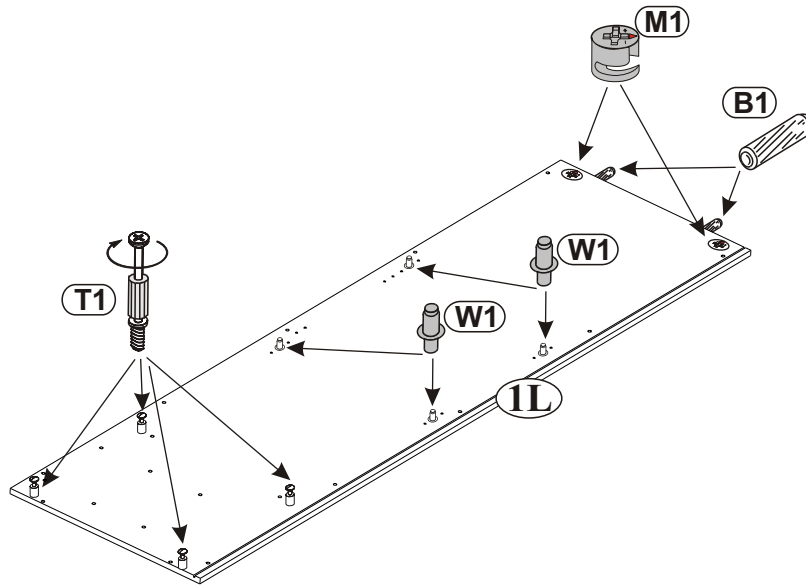
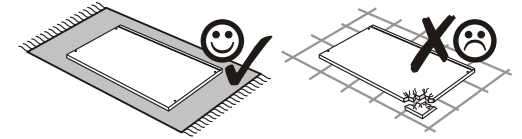

<b>M1</b>  x4	<b>B1</b>  8x28 x4	<b>E3</b>  6,3x13 x8
<b>T1</b>  x8	<b>D7</b> H4  x4	<b>W1</b>  x8

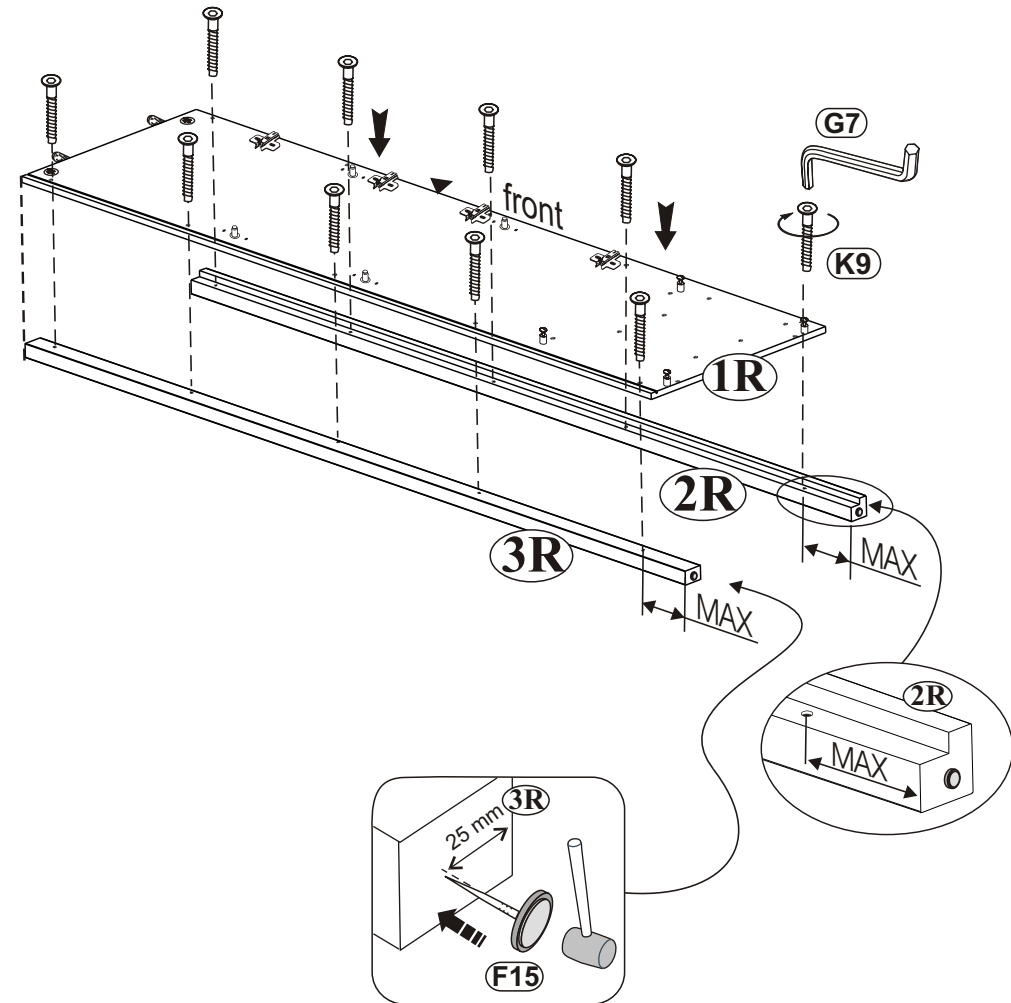
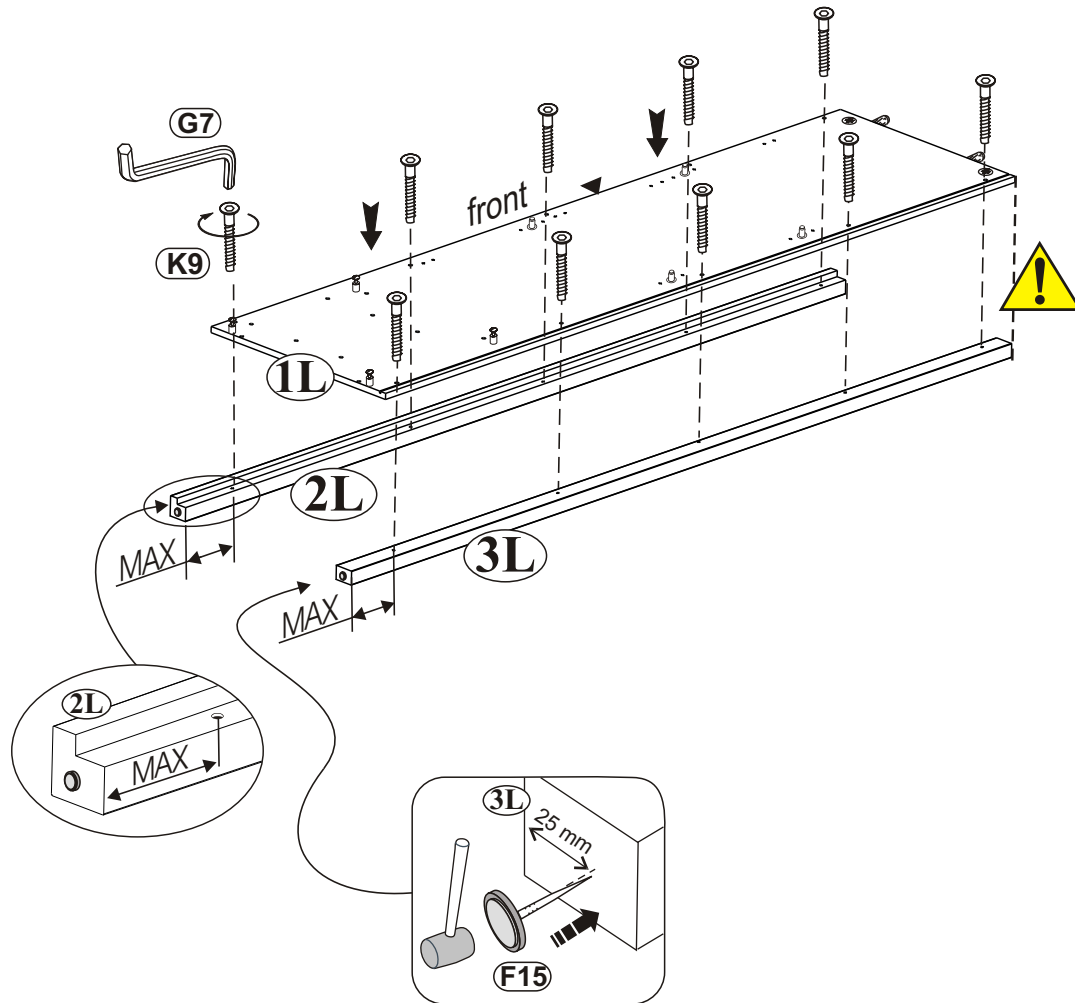
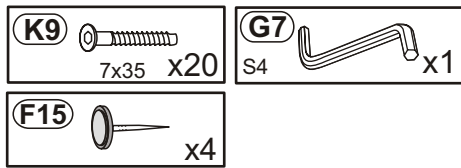

2



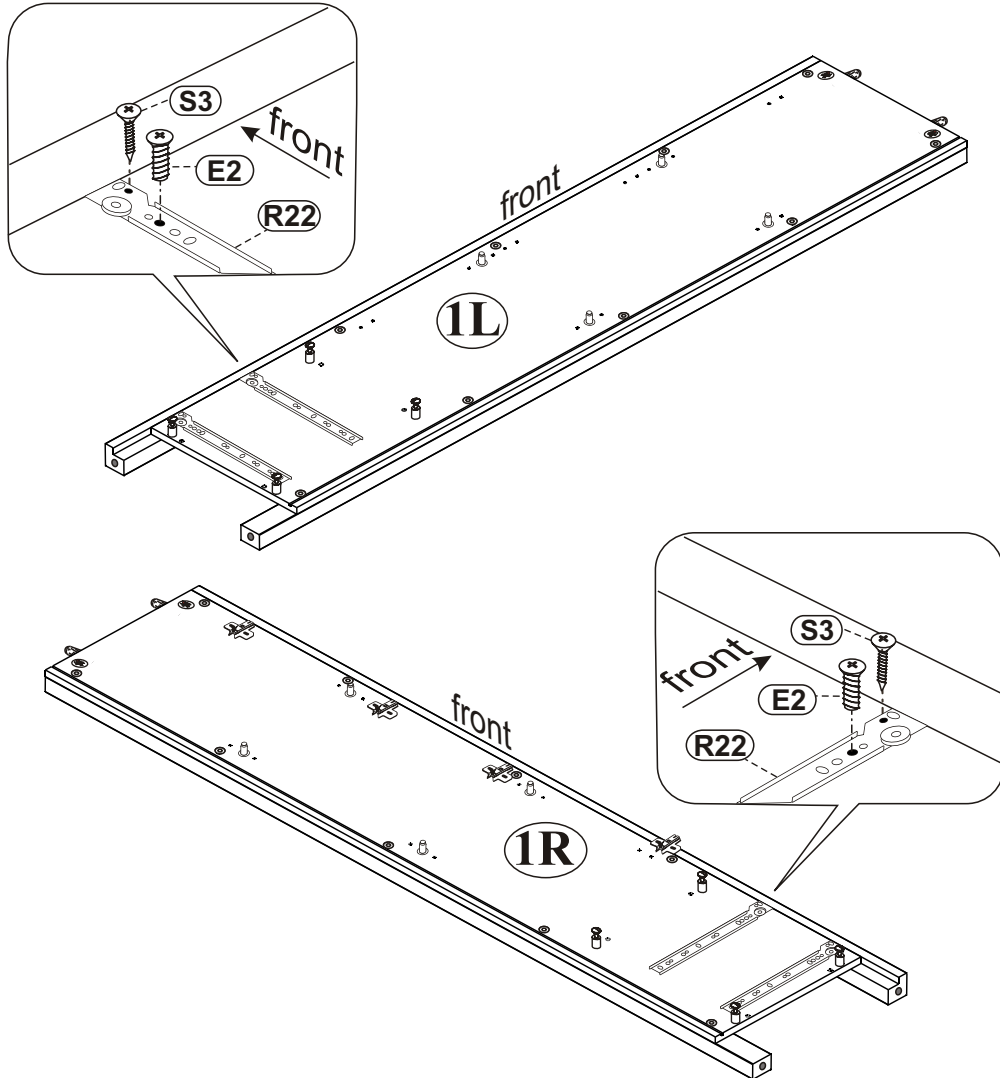

3

- |   |          |           |   |        |     |
|---|----------|-----------|---|--------|-----|
| <b>R22</b>  | L-350 mm | <b>E2</b> |  | 6x11   | x12 |
|  |          | <b>S3</b> |  | 3,5x13 | x4  |
|   | x2L/2R   |           |   |        |     |

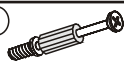

4

- |           |   |      |    |
|-----------|---|------|----|
| <b>B1</b> |  | 8x28 | x8 |
| <b>M1</b> |  |      | x8 |
| <b>T1</b> |  |      | x4 |

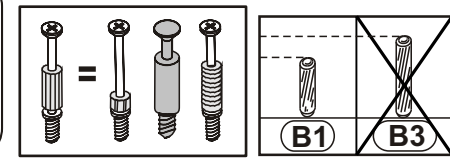
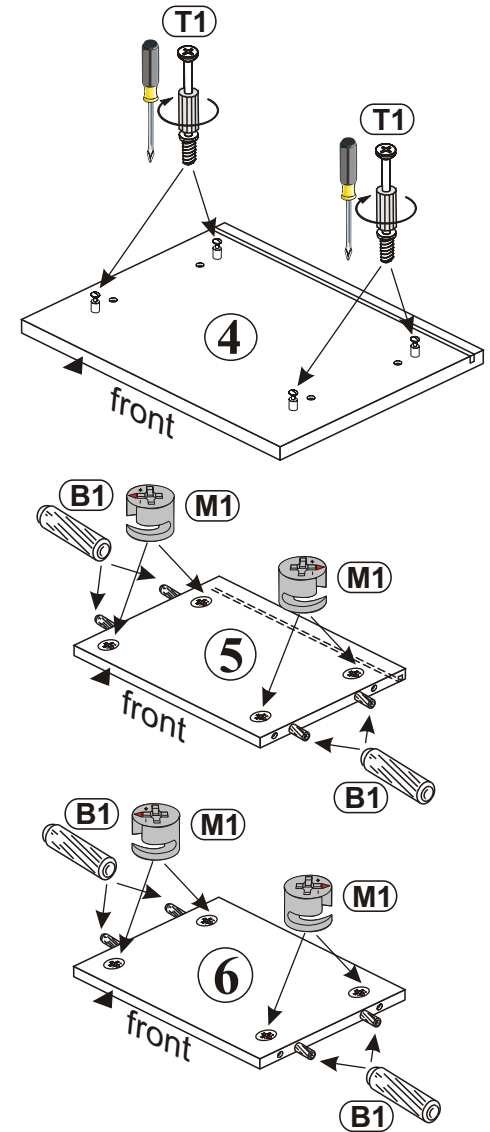
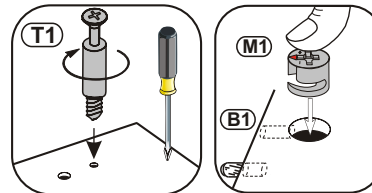
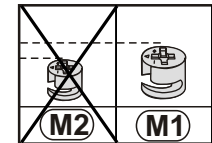
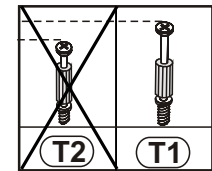

5

- Y1** Kr15 x4
- S8** 4x13 x8
- U61** x1
- A14** M4x23 x1

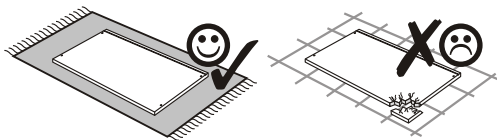
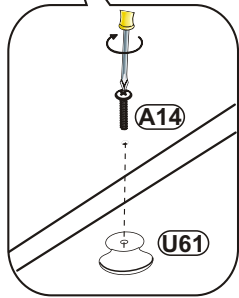
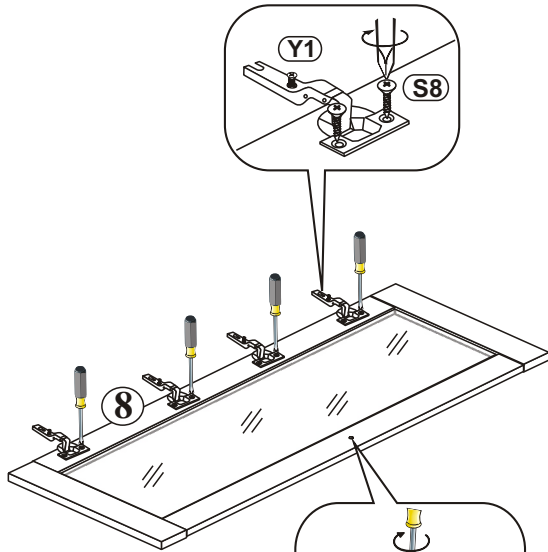

6

- R22** L-350 mm x2L/2R
- P5** 4x30 x8
- U61** x2
- M2** 12x10mm x4
- A14** M4x23 x2
- P3** 3x13mm x8
- T2** 5x35mm x4
- J23** x4

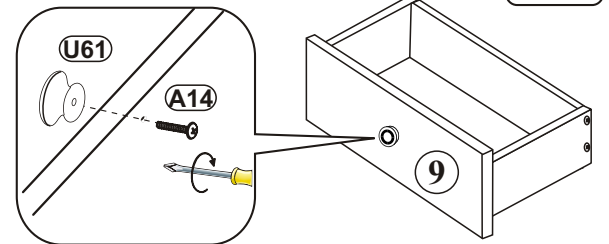
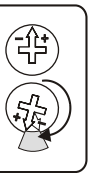
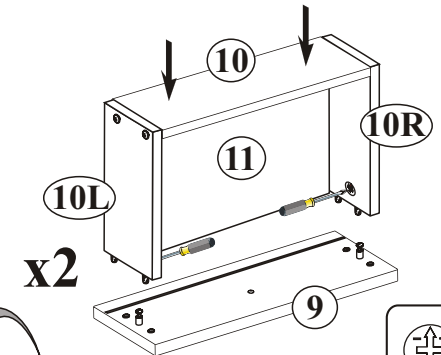
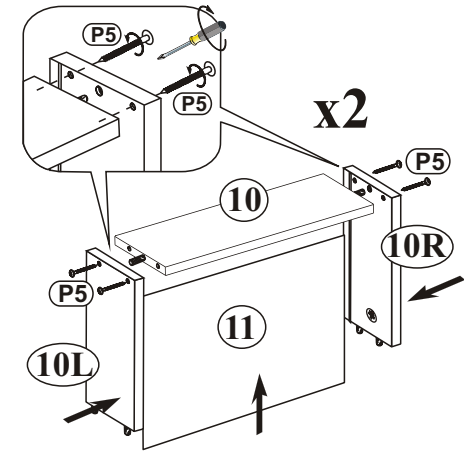
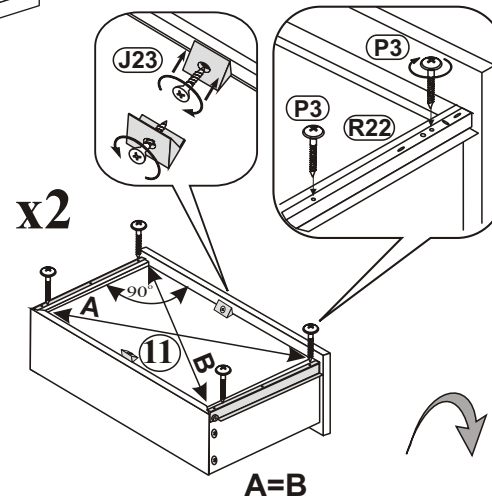
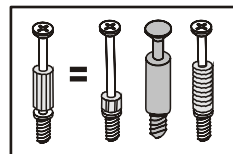
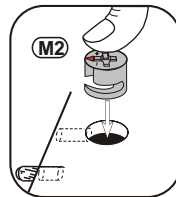
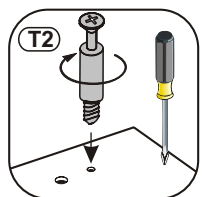
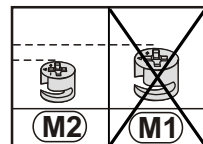
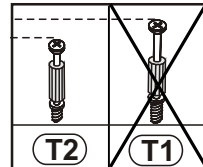
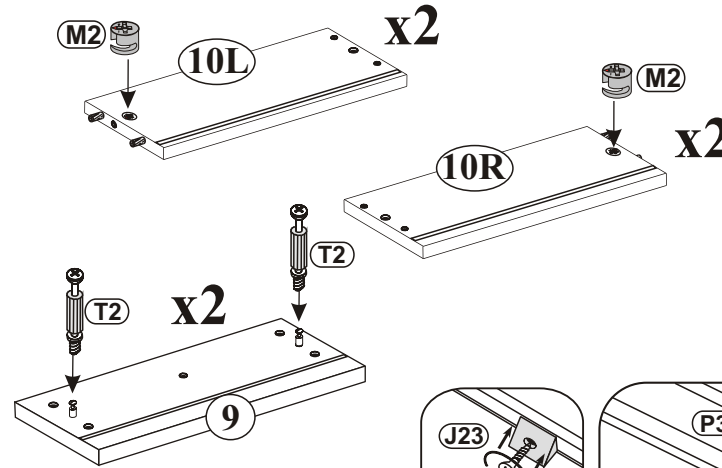

7

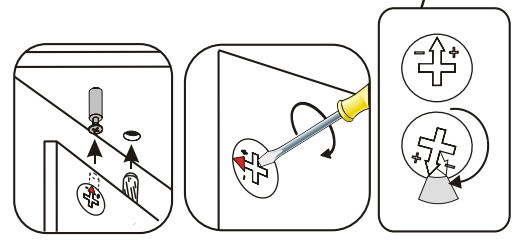
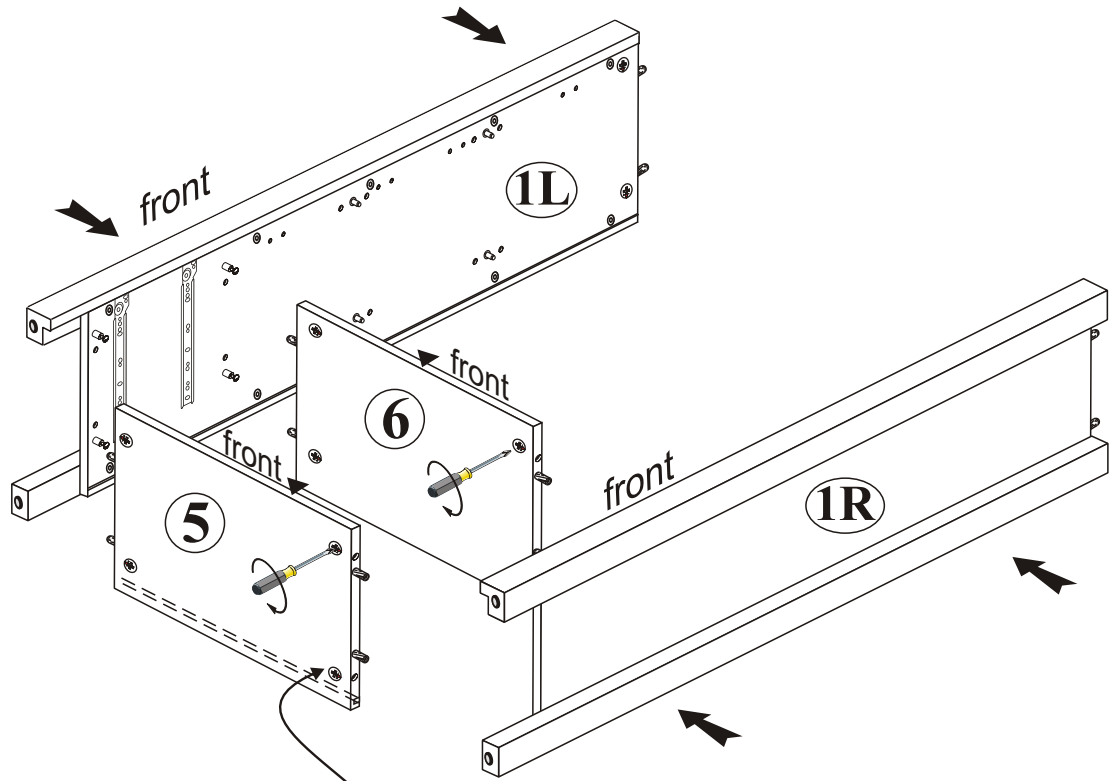

8

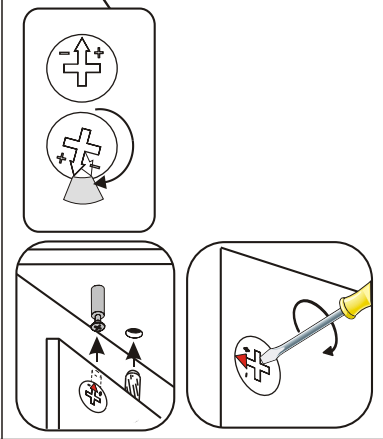
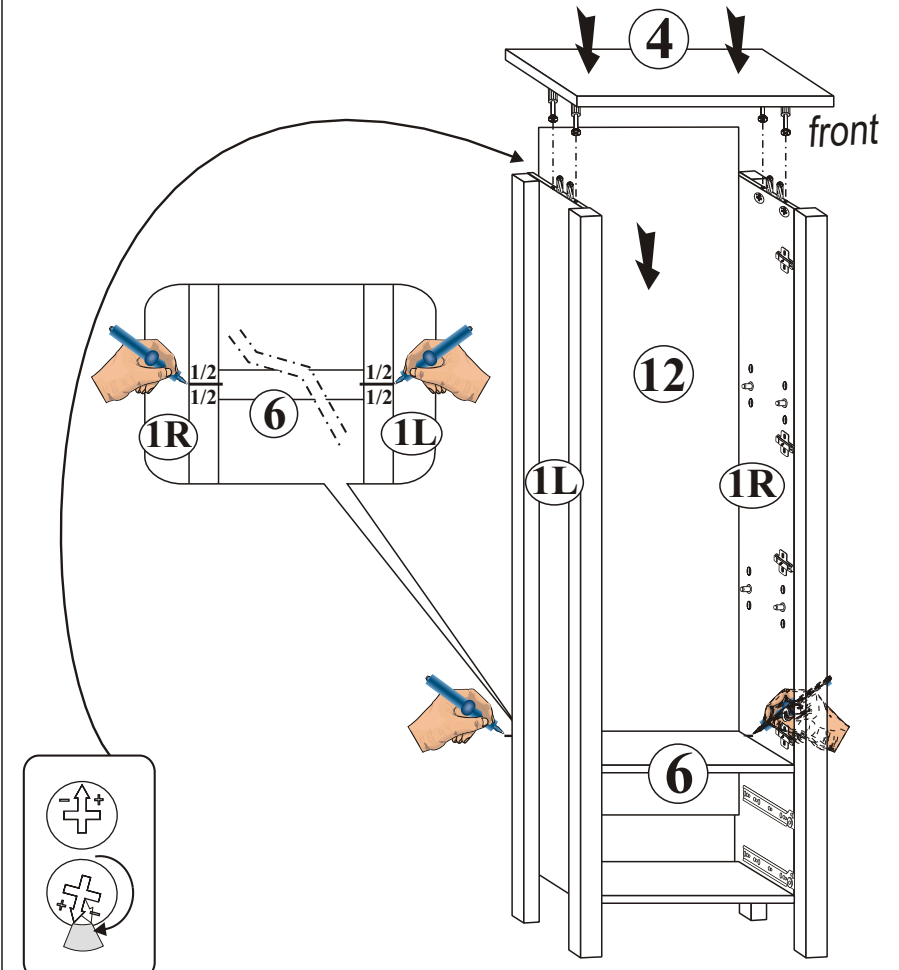

9

- S4** 3,0x20 x3
- J23** x20

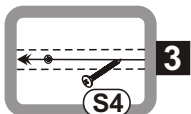
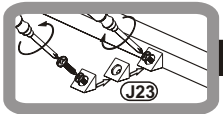
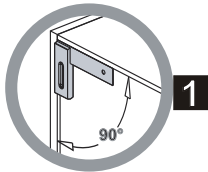
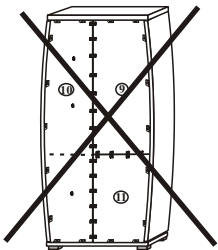
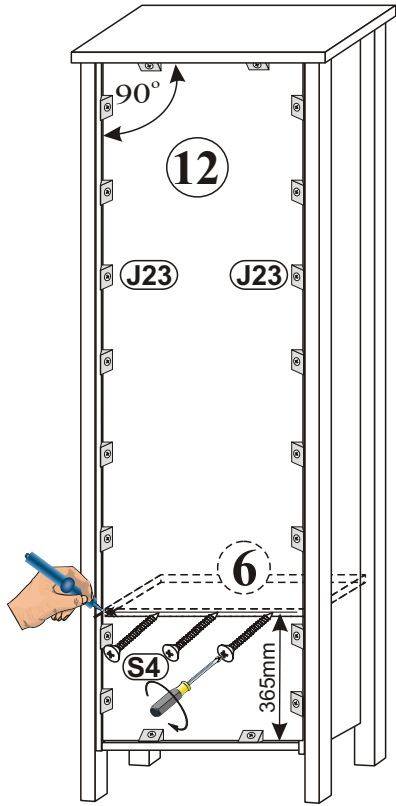

10

- J11** 1
- 2
- 3
- P13** **J11** 4
- J11** 5

- J11** x1
- P13** 3,5x13 mm x2
- C14** mm x4

