

COUNTRY

8X--CT 04

1 / 11

B - 2095mm  
H - 2180mm  
T - 604mm

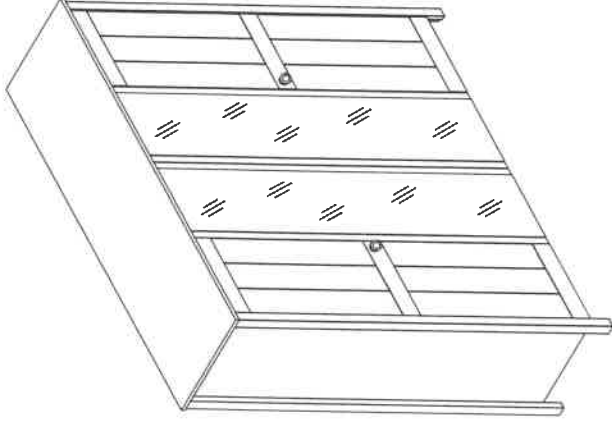

Tools: screwdriver, pliers, hammer, level, key, scissors, utility knife, pencil.

Icons: two people, a hand holding a box, a hand holding a child, a clock showing 2h, a drill bit labeled Ø8.

Icons: correct/incorrect box handling, correct/incorrect door opening, correct/incorrect drilling.

Icons: no fire, no hot liquids, no sharp objects, no heavy lifting, no climbing.

Icons: 100% COTTON gloves, no sharp objects, no heavy lifting, no climbing.

Eye safety icon: correct eye protection (thumbs up), incorrect eye protection (thumbs down).

Large safety warning icons: falling objects, sharp edges, climbing.

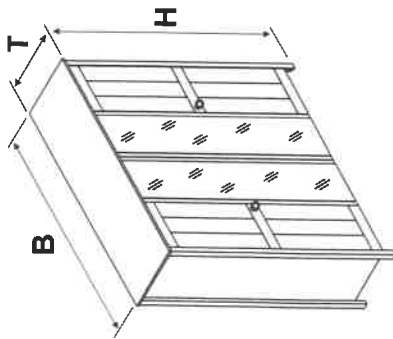

B - 2095mm  
H - 2180mm  
T - 604mm

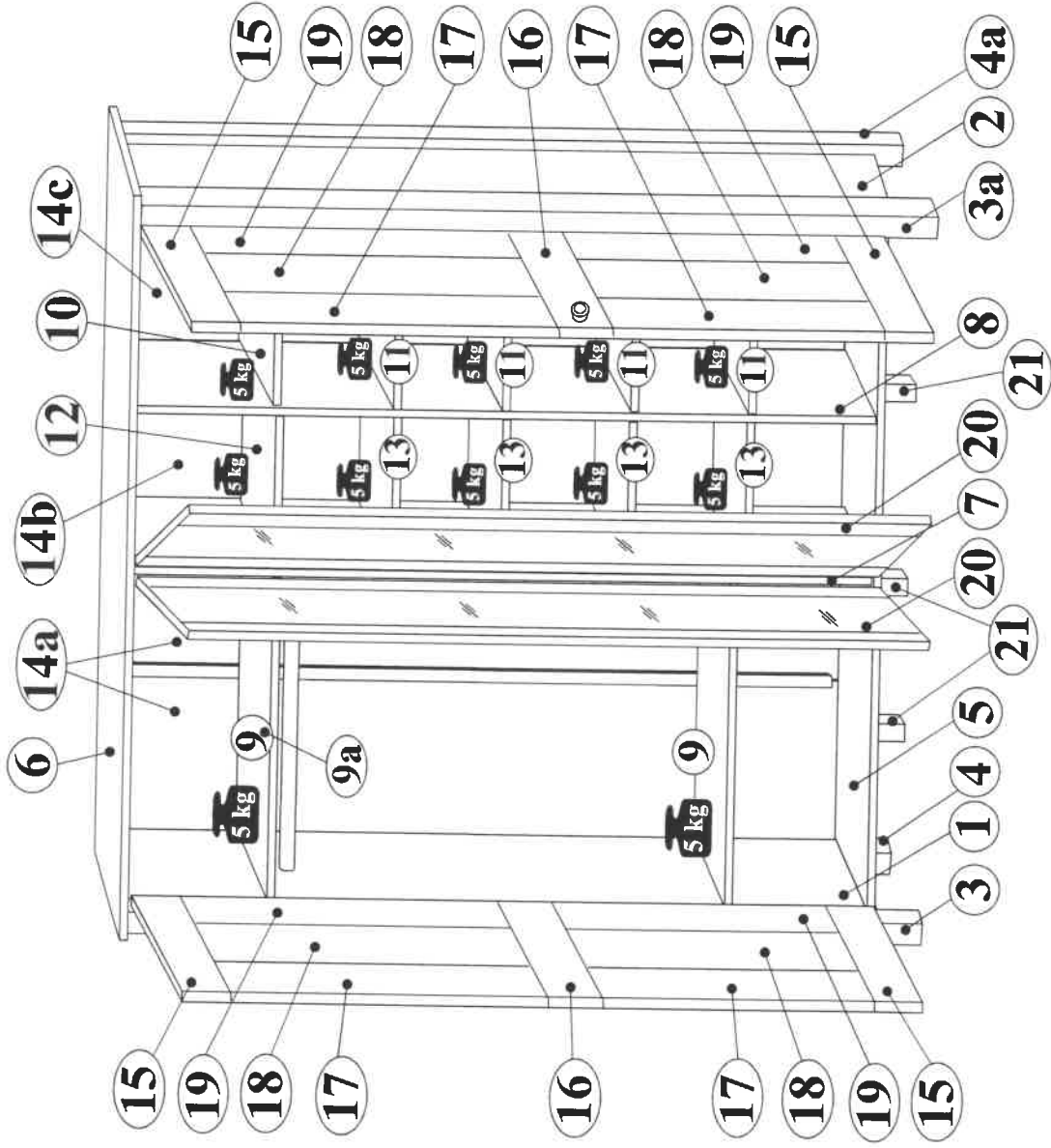

<b>NR 1</b>	<b>B1</b> φ 8x28 x24	<b>B2</b> φ 8x50 x4	<b>B3</b> φ 6x45 x48	<b>M1</b> x32+16	<b>T1</b> x24+16	<b>T12</b> L=24/40 x4	<b>W1</b> x32	<b>K1</b> φ 7x50 mm x3	<b>K9</b> 7x35 x24
-------------	----------------------------	---------------------------	----------------------------	---------------------	---------------------	-----------------------------	------------------	------------------------------	--------------------------

<b>NR 2</b>	<b>C14</b> φ20mm x49	<b>S4</b> 3,0x20 x12	<b>M6</b> x12	<b>P16</b> 4,2x12 x12	<b>F15</b> x7	<b>G7</b> S4 x1	<b>C17</b> 1,5mm x4
-------------	----------------------------	----------------------------	------------------	-----------------------------	------------------	-----------------------	---------------------------

<b>NR 3</b>	<b>Y1</b> Kr15 x8	<b>D7</b> H4 x8	<b>S8</b> 4x13 x16	<b>E3</b> 6,3x13 x16
-------------	-------------------------	-----------------------	--------------------------	----------------------------

<b>NR 4</b>	<b>Y2</b> Kr8 x8	<b>D6</b> H2 x8	<b>S8</b> 4x13 x16	<b>E3</b> 6,3x13 x16
-------------	------------------------	-----------------------	--------------------------	----------------------------

<b>NR 5</b>	<b>U61</b> x2	<b>A14</b> M4x23 x2	<b>NR 6</b>	<b>F7</b> x2	<b>S1</b> ∅3,0x13mm x2
-------------	------------------	---------------------------	-------------	-----------------	------------------------------

<b>NR 7</b>	<b>J11</b> x2	<b>P13</b> 3,5x13 mm x4
-------------	------------------	-------------------------------

<b>J20</b> L=973mm x1	<b>J22</b> L=2036 mm x1
-----------------------------	-------------------------------

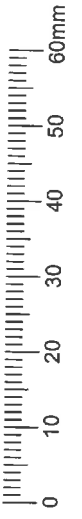

1



x4



x10



x4



x1



x1



x16



x8



x8



x8



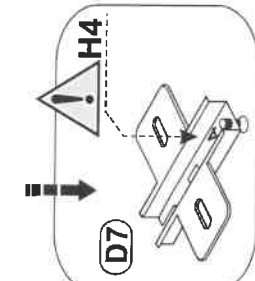
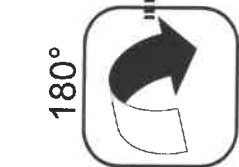
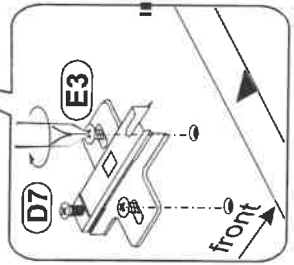
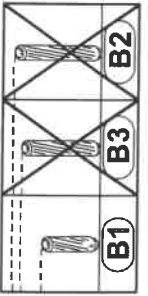
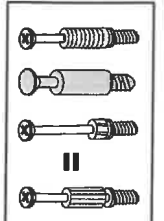
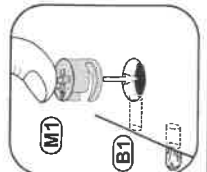
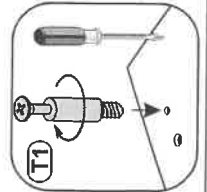
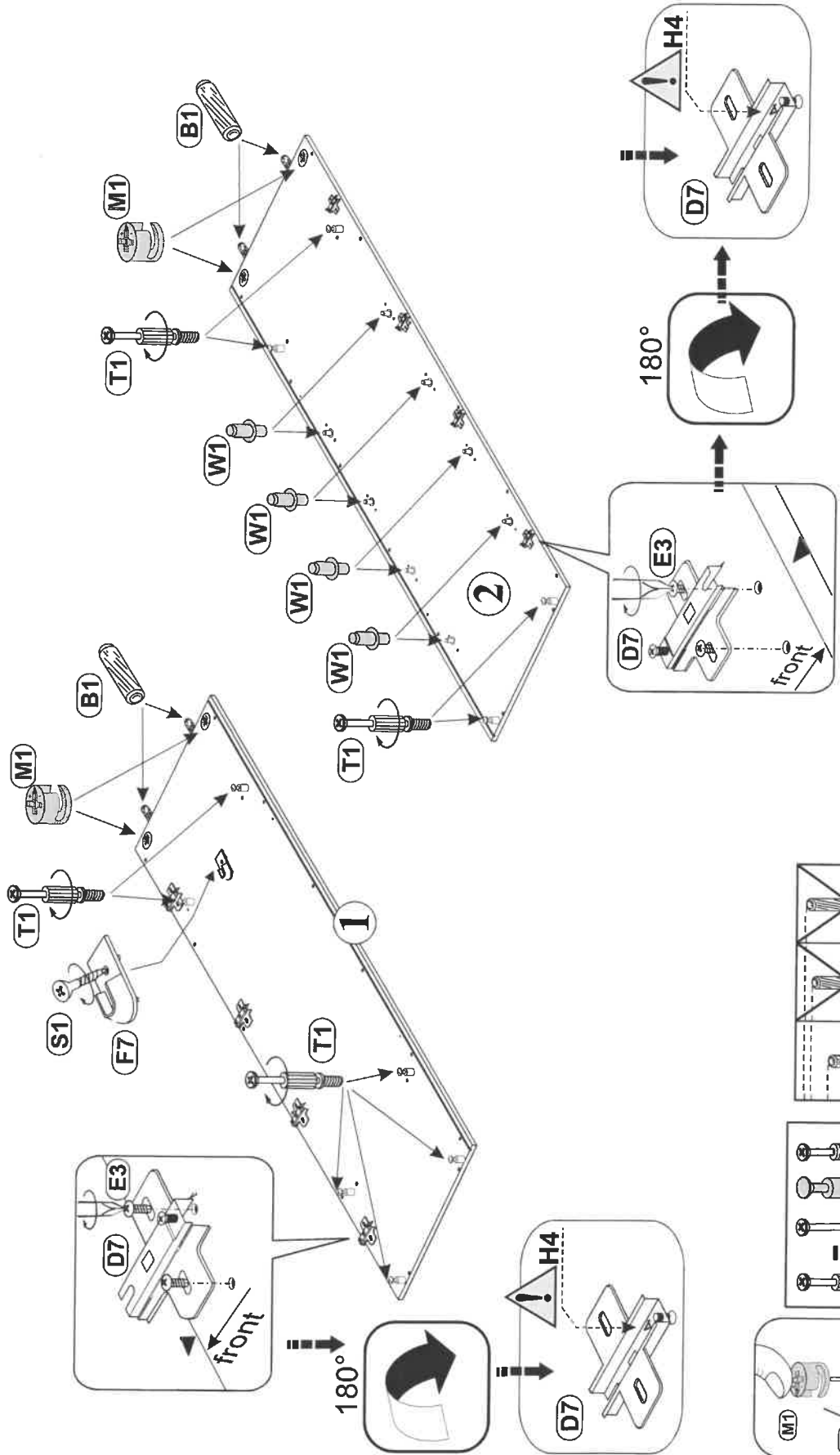

x8



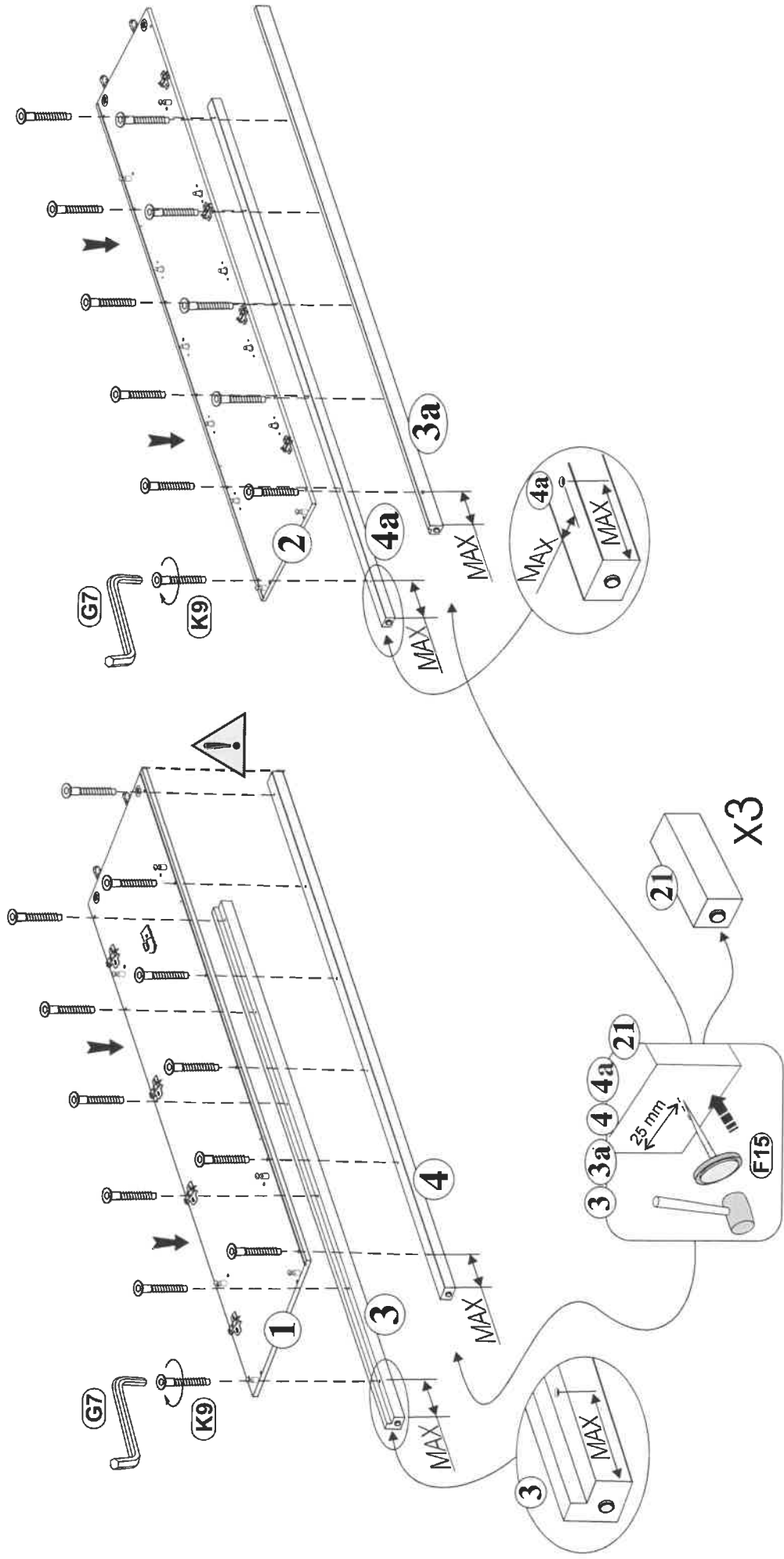
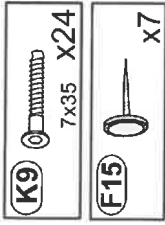

2



3





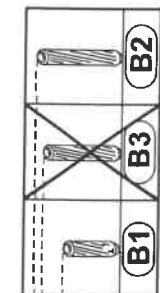
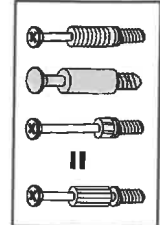
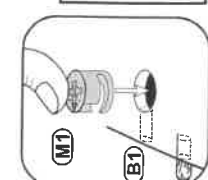
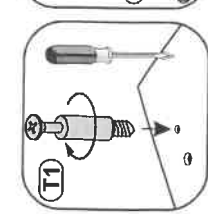
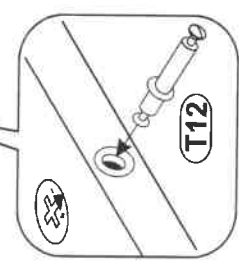
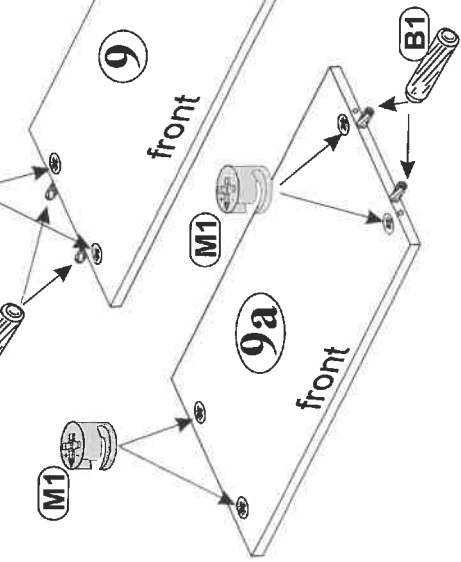
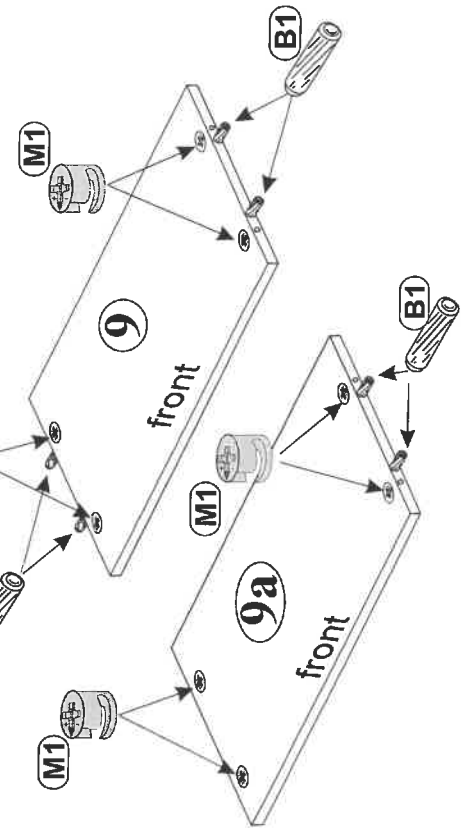
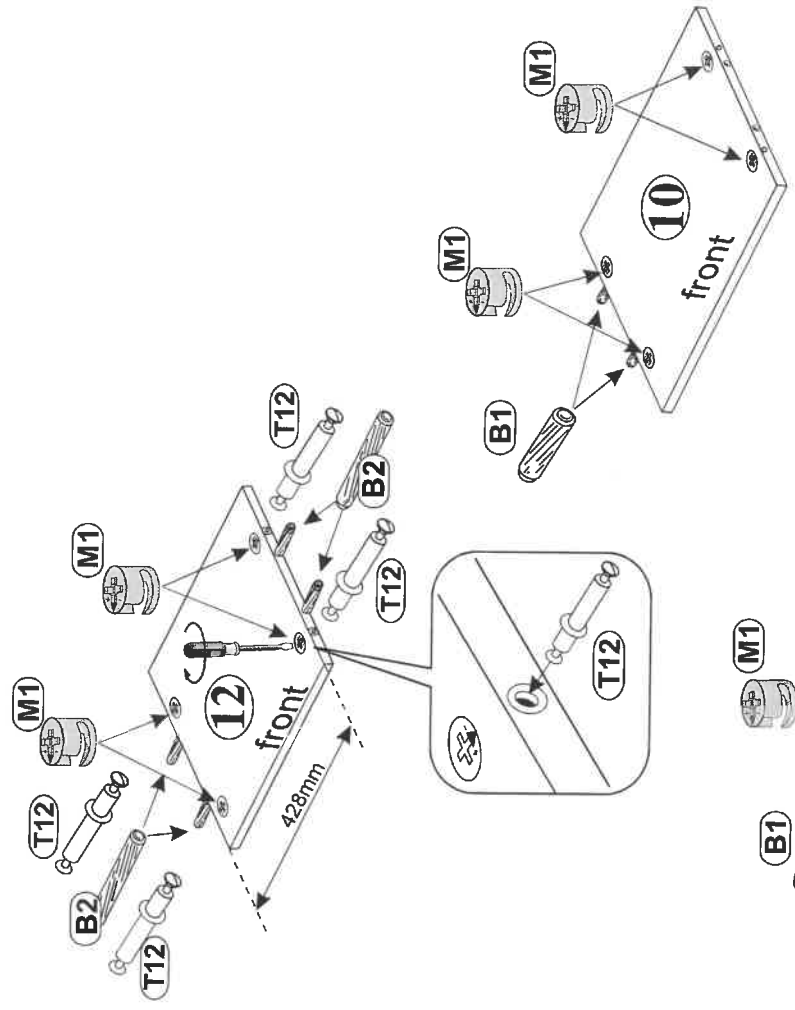
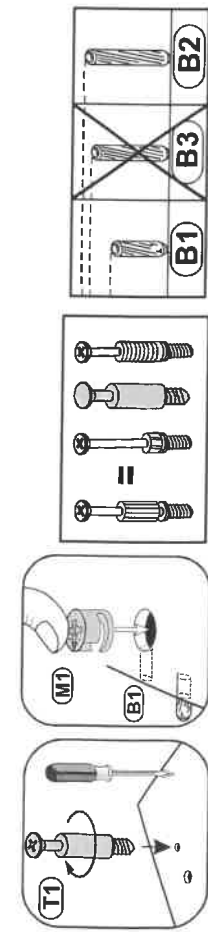
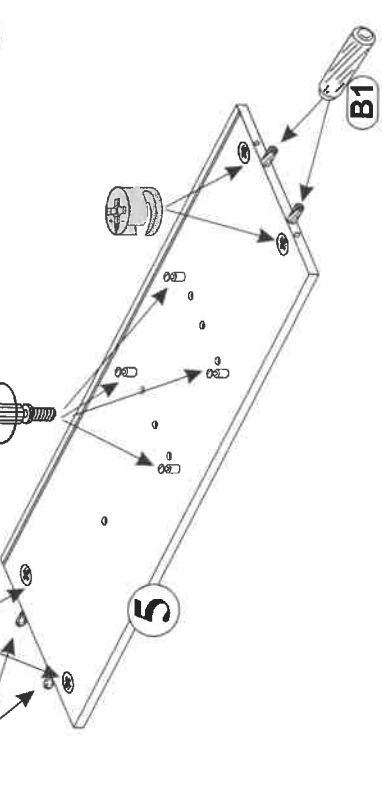
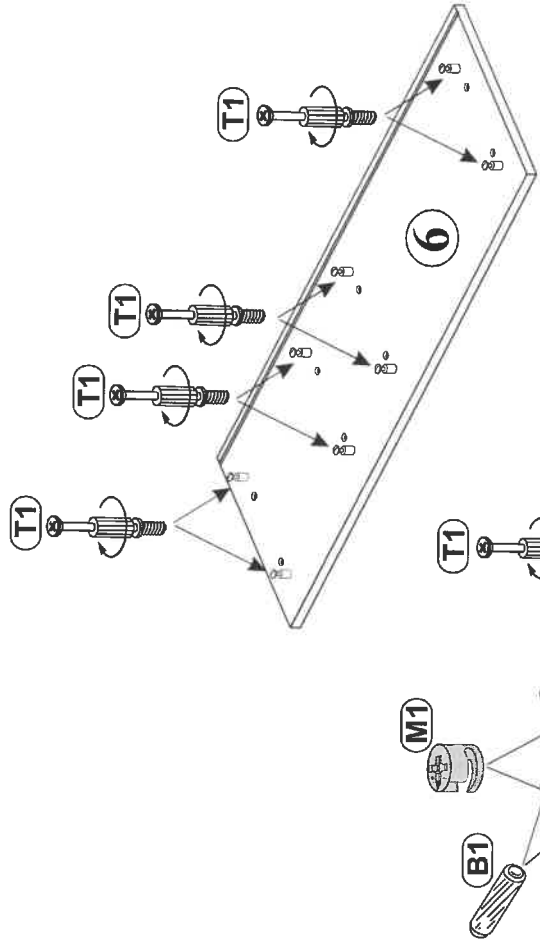

<b>B1</b>		φ 8x28	x12
<b>B2</b>		φ 8x50	x4

<b>M1</b>		x20
<b>T1</b>		x12

<b>T12</b>		L=24/40	x4
------------	---	---------	----

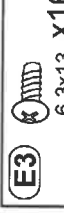

4

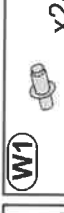
-  M1 x8
-  B1 φ 8x28 x8
-  T1 x2
-  S1 Ø 3,0x13mm x1
-  F7 x1
-  E3 6,3x13 x16
-  D6 H2 x8
-  W1 x24

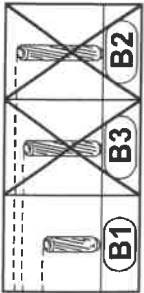
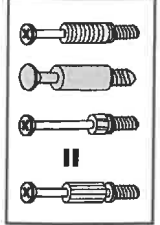
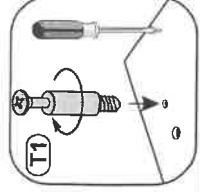
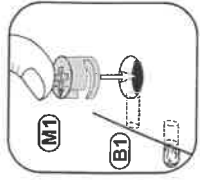
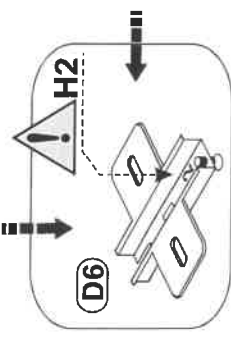
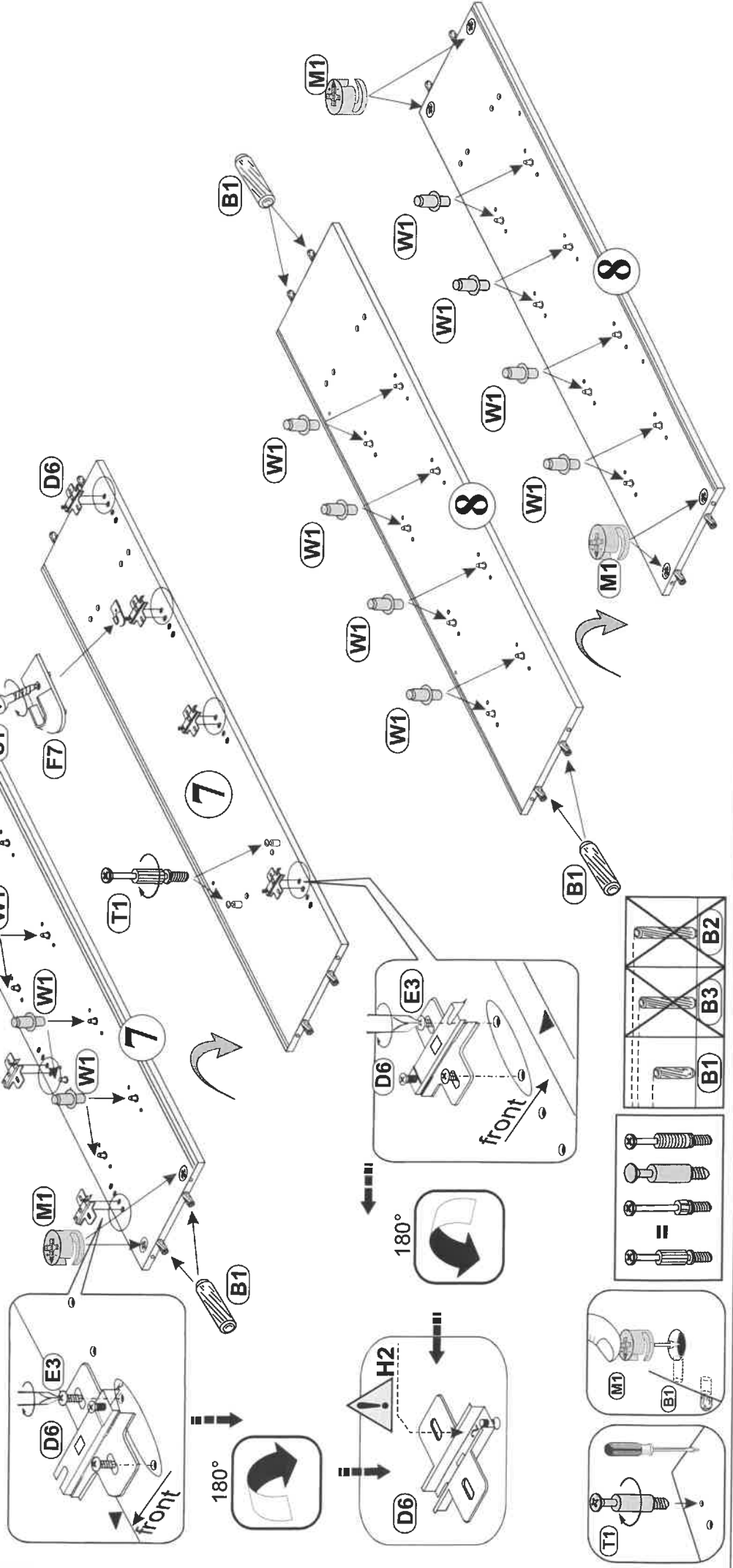

**5**   $\phi$  7x50 mm X3

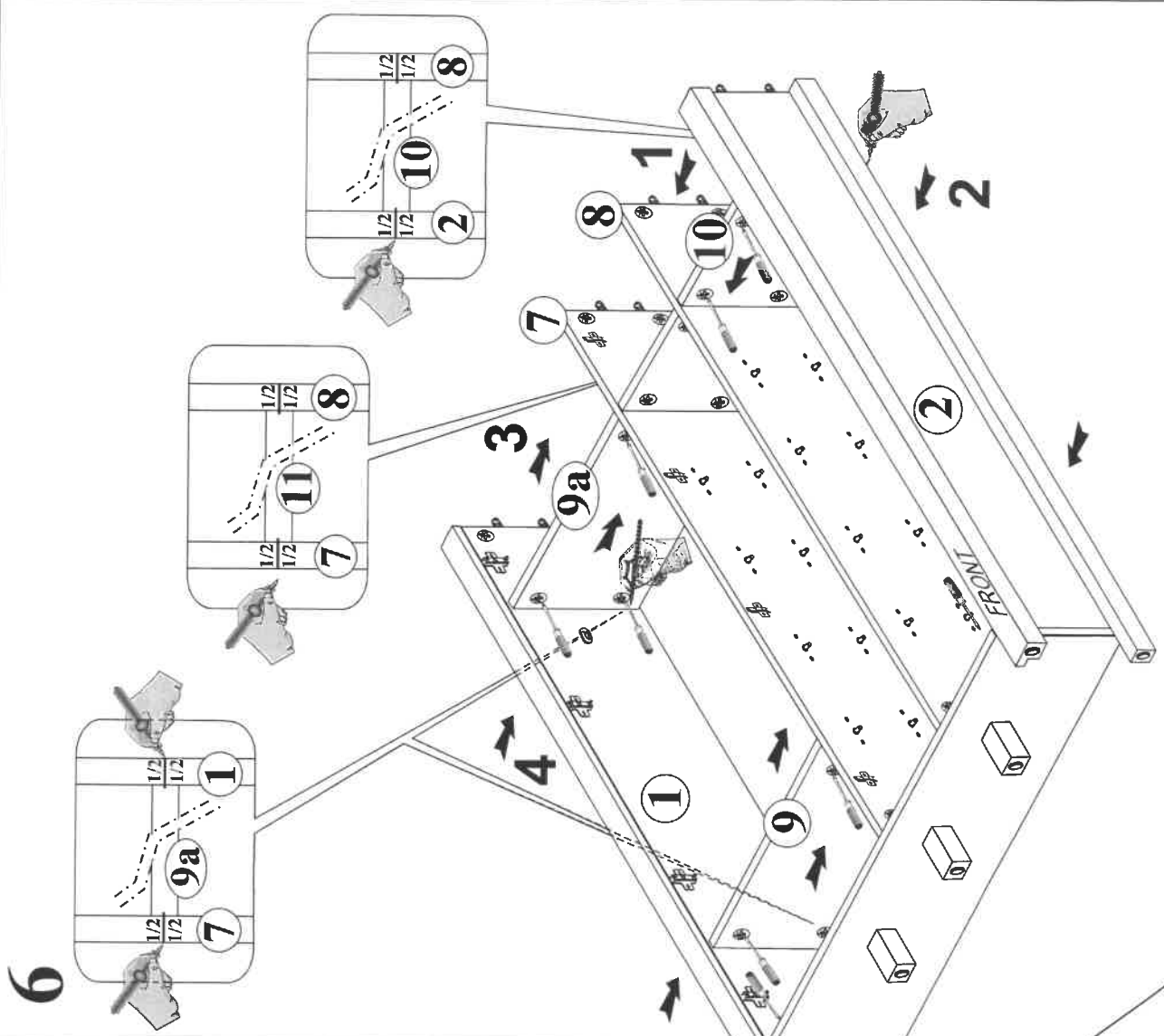
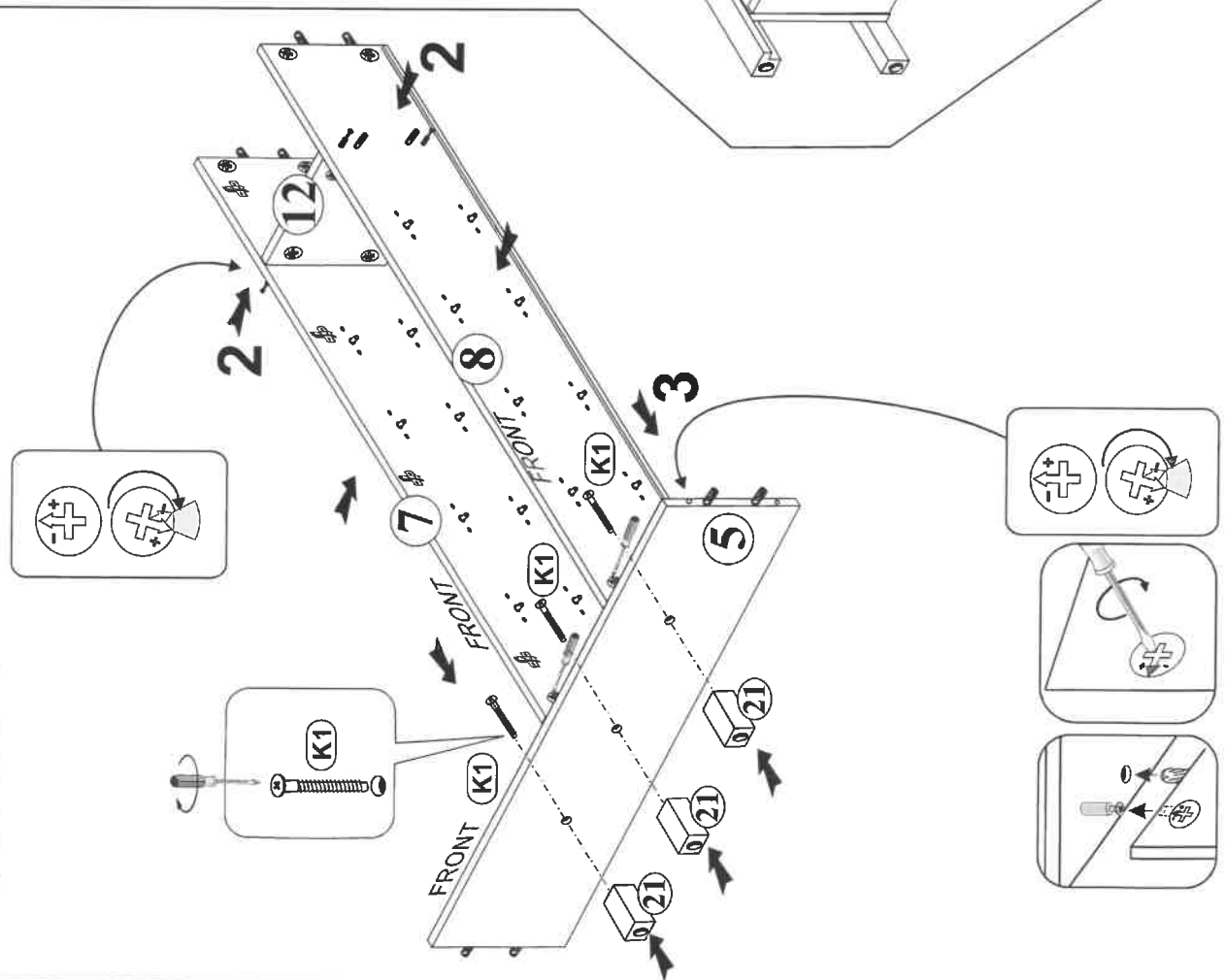



7

- M6** x12
- P16** 4,2x12 x12
- J20** L=973mm x1
- J22** L=2036 mm x1

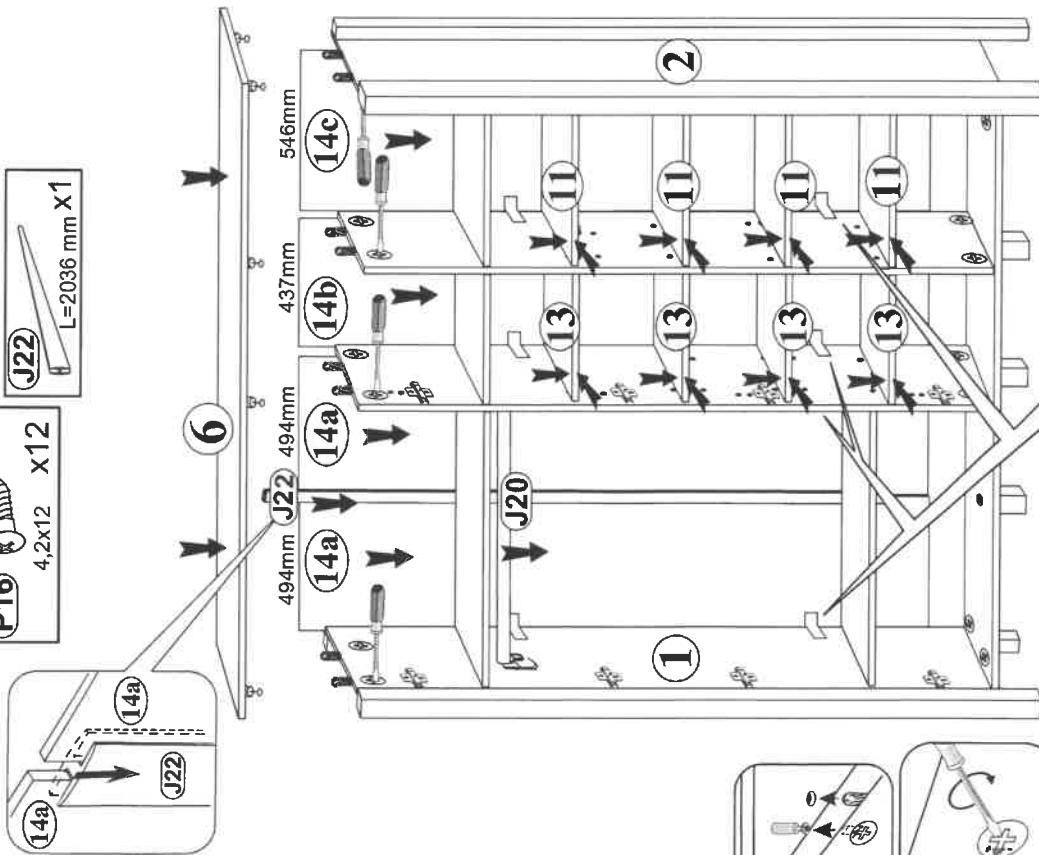

8

- S4** 3,0x20 x12

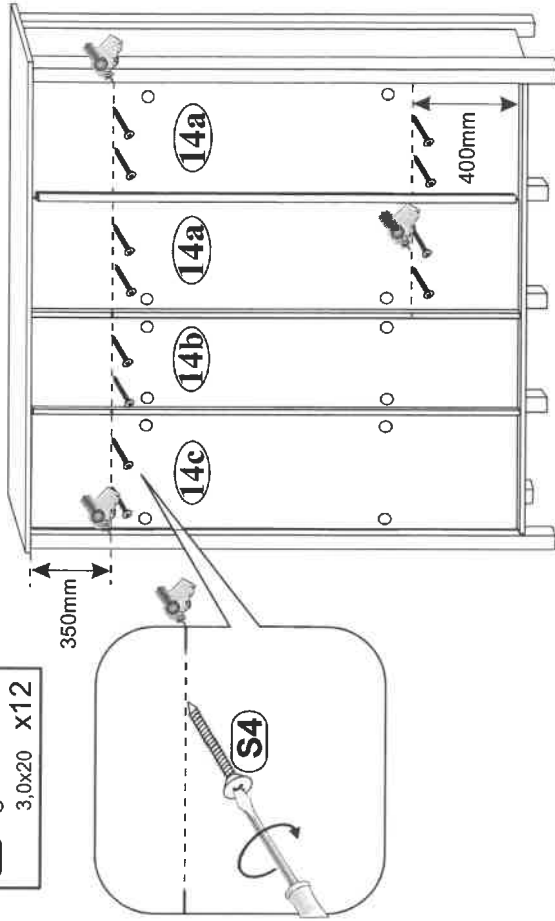

9

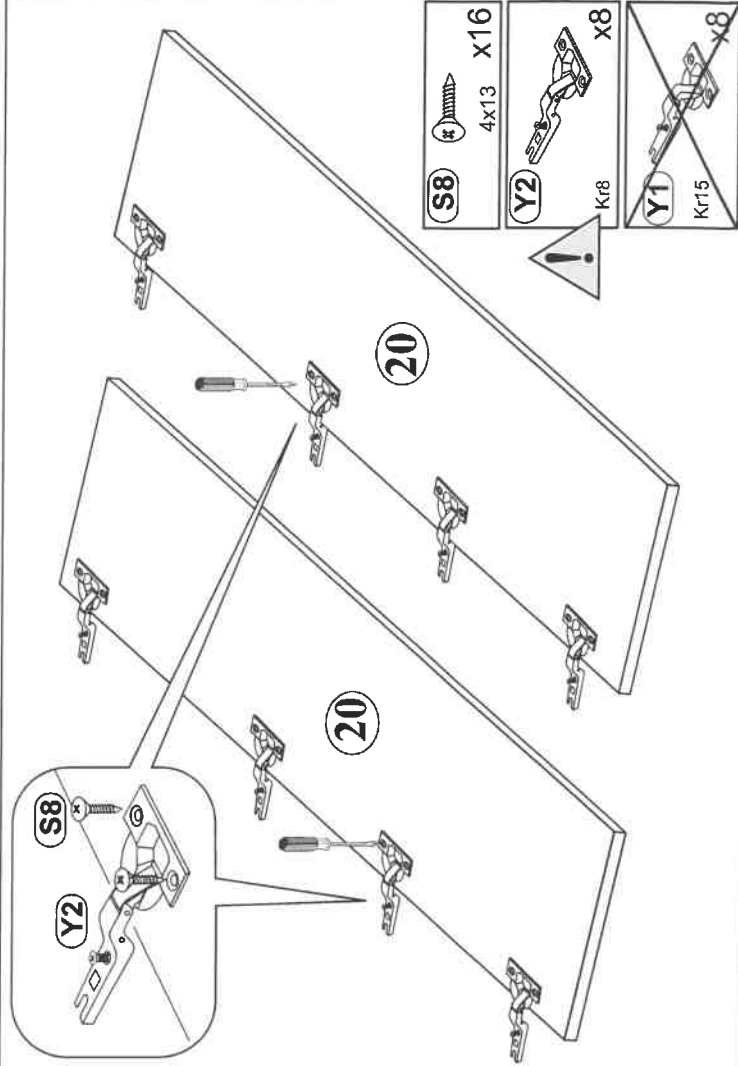

10



x16



x16



φ 6x45 x48



x8  
Kr15



x16  
4x13





x2

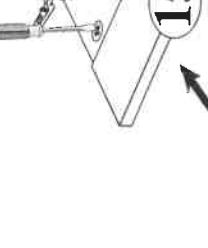
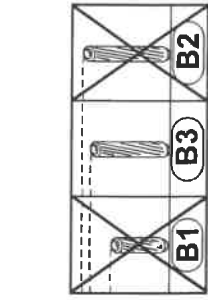
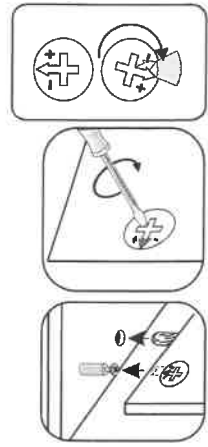
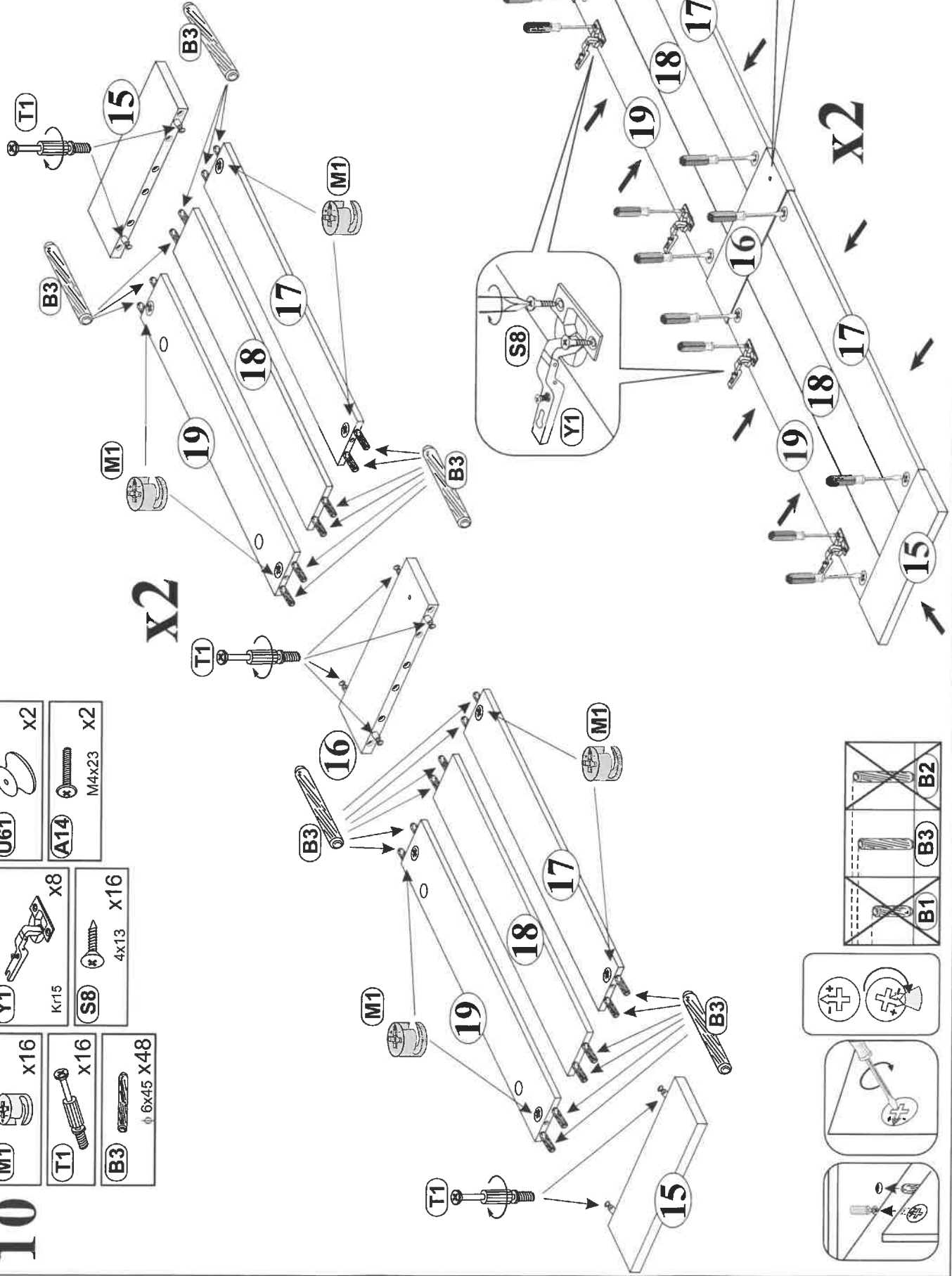

M4x23 x2

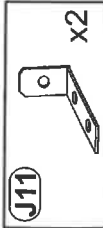
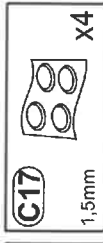
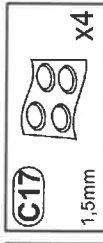

11

		
x2	1,5mm	x49
		
3,5x13 mm	φ20mm	

