

Modellname:
Nazwa modelu:

BLITZ II

Modellreihe:
Numer modelu:

8X--BL03

Blatt Nr
Strona Nr

1/9

[D] MONTAGEANLEITUNG [GB] ASSEMBLY INSTRUCTIONS [PL] INSTRUKCJA MONTAŻU

D Sehr geehrter Kunde, sollte ein Teil fehlen oder beschädigt sein, kreuzen Sie bitte dieses deutlich auf der Montageanleitung an und schicken Sie zu uns ab.

GB Dear customer, should there be any place missing or damaged, kindly mark this place clearly on the attached assembly instructions and return it to us.

F Cher client, Lorsque vous constatez qu'une pièce est manquante ou abîmée, nous vous prions de bien vouloir la marquer d'une croix sur les instructions d'assemblage et de nous retourner ces instructions d'assemblage.

PL Szanowny Kliencie, gdyby brakowało jakiegóś części lub byłaby uszkodzona proszę to oznaczyć krzyżykiem na instrukcji montażowej i przesłać razem z reklamacją.

Für die Montage dieser Type benötigen Sie:

Do montażu potrzebne są:



2 Personen
2 osoby

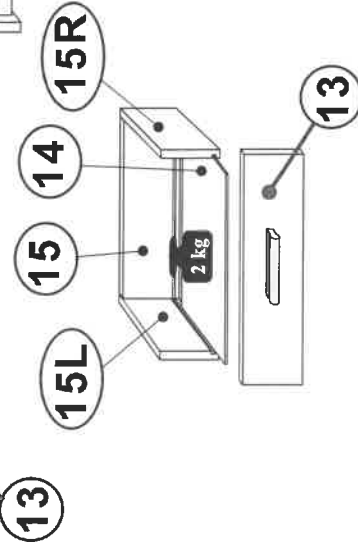
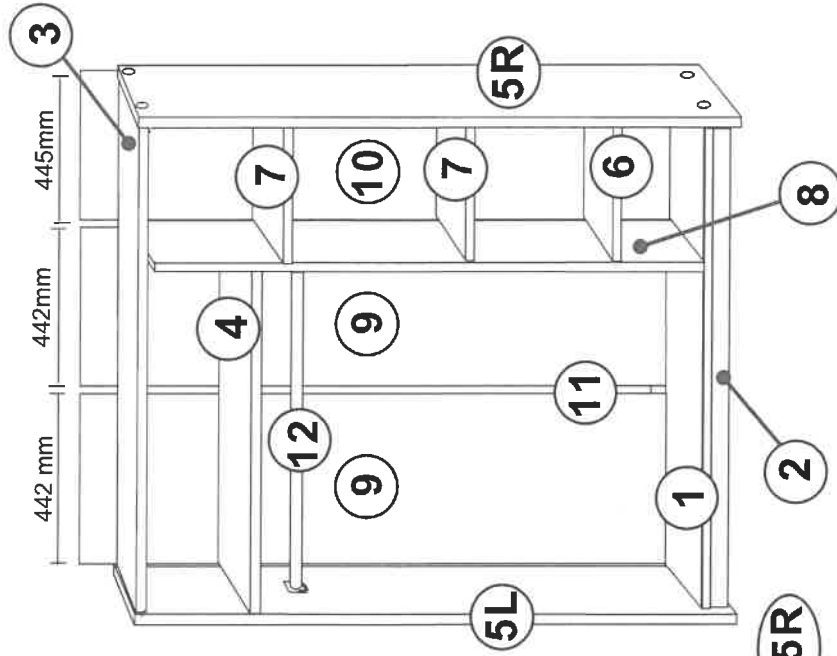
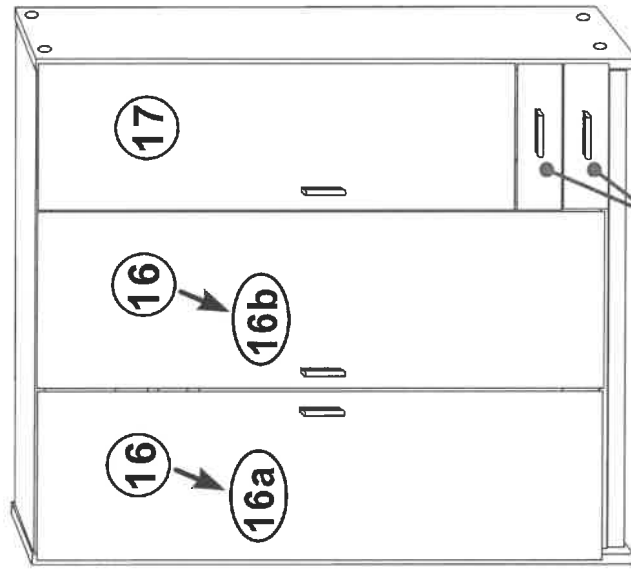

Max.zulässige Belastungen von Einlegeböden in kg:
Max.obciążenie polek w kg:

Länge/ długość	Stärke/ grubość	Spanplatte/Płyta			
		16	20	25	32
0 ÷ 400					
401 ÷ 600	40 kg		40 kg	40 kg	40 kg
601 ÷ 800	24 kg				
801 ÷ 1000	15 kg		30 kg		
1001 ÷ 1200	10 kg		21 kg	21 kg	35 kg

Pflegehinweis!
Bitte nur mit einem Saubertuch oder einem feuchtem Lappen reinigen. KEINE scheuernde Putzmittel verwenden!

Uwagi pielęgnacyjne!
Proszę wycierać ściereczką do kurzu lub lekko wilgotną ścierką. Nie stosować ŻADNYCH środków rysujących powierzchnie.

Modellname:
Nazwa modelu :

BLITZ II

Modellreihe: **8X--BL03**
Numer modelu:

Blatt Nr **2/9**
Strona Nr

Worek Beutel 1

D x 20	D1 x 12	H x 8	I x 12	L x 2	L1 x 2	Q x 2

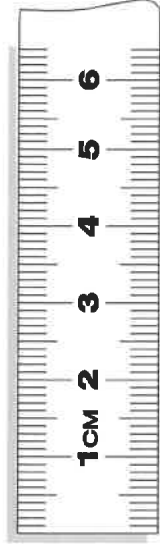

Worek Beutel 2

Z x 12	Z1 x 64	D Leim
		GB Glue
		F Colle
		PL Klej
		x 2

Worek Beutel 3

Y0 Kf0	S8 4x13	D6 H2	E3 6,3x13
φ35 x6	x12	x6	x12

Worek Beutel 4

Z3 KR8Z	S8 4x13	D1 H0	E3 6,3x13
x3	x6	x3	x6

Worek Beutel 5

R22 L-350 mm	E24 6x11	P10 3,0x13	S3 3,5x13	M2 φ12x10mm	T2 5x32mm	P5 4x30
x2L/2R	x12	x8	x4	x4	x4	x8

Worek Beutel 6

D128	A14 M4x22
x5	x10

Modellname:
Nazwa modelu:

BLITZ II

Modellreihe: **8X--BL03**
Numer modelu:

Blatt Nr **3/9**
Strona Nr

1

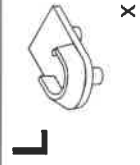

D Leim
GB Glue
F Colle
PL Klej
x1

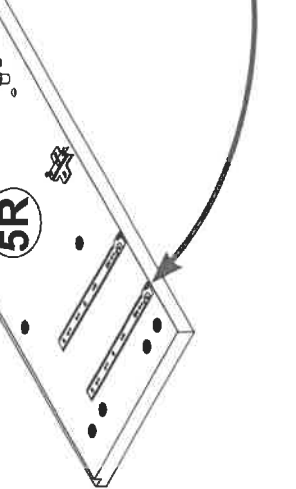
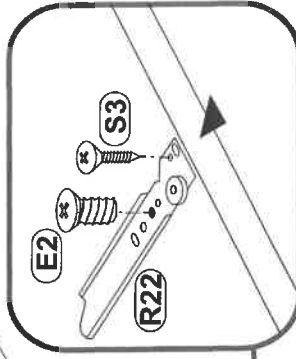
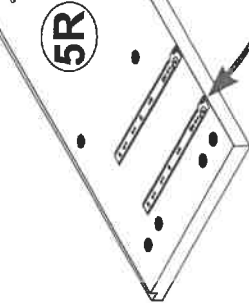
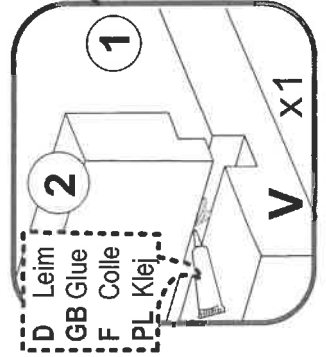
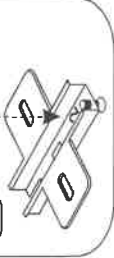
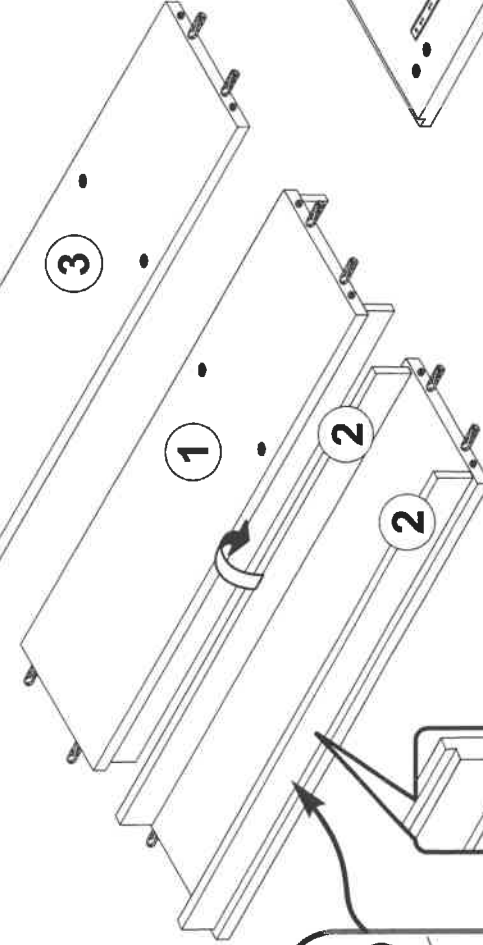
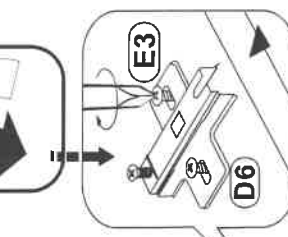
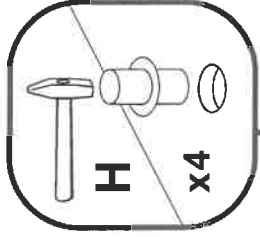
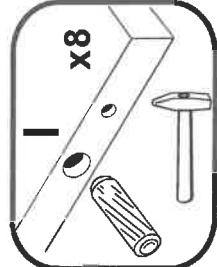
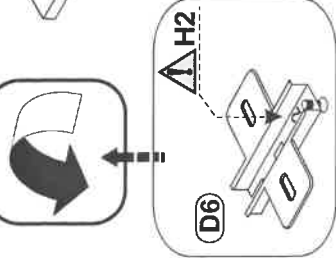
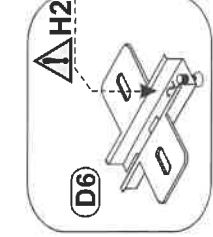
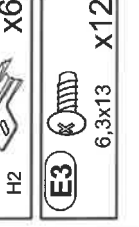
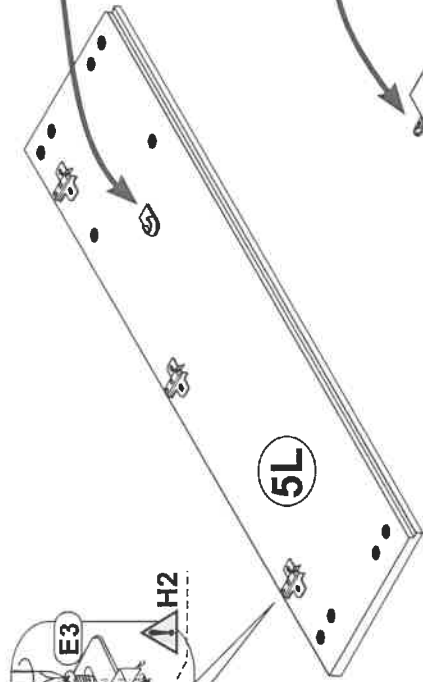
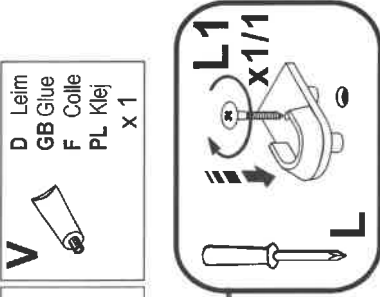
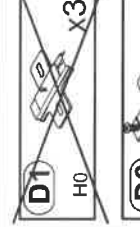

Modellname:
Nazwa modelu:

BLITZ II

Modellreihe:
Numer modelu:

8X--BL03

Blatt Nr
Strona Nr

4/9

2

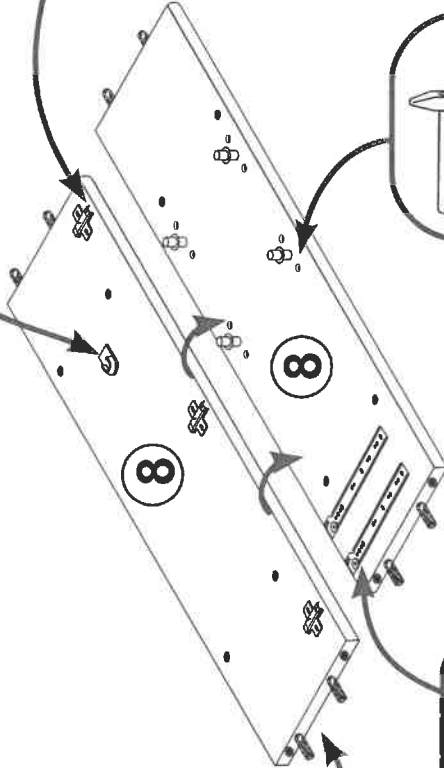
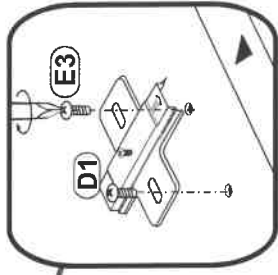
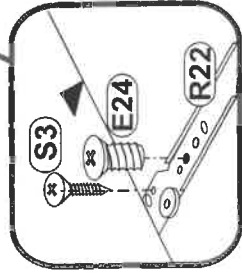
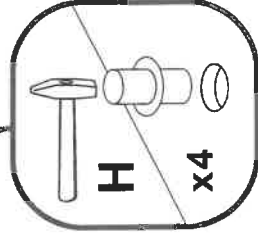
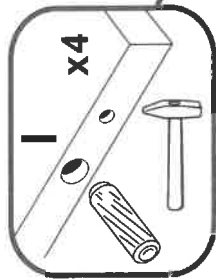
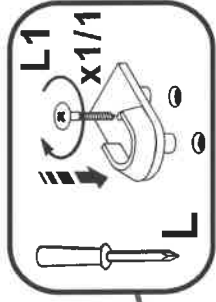
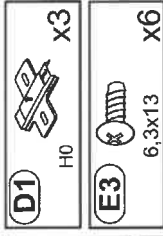
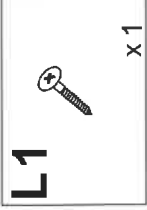
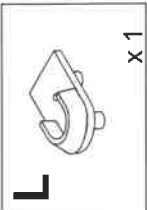

Modellname:
Nazwa modelu :

BLITZ II

Modellreihe: **8X--BL03**
Numer modelu:

Blatt Nr **5/9**
Strona Nr

3

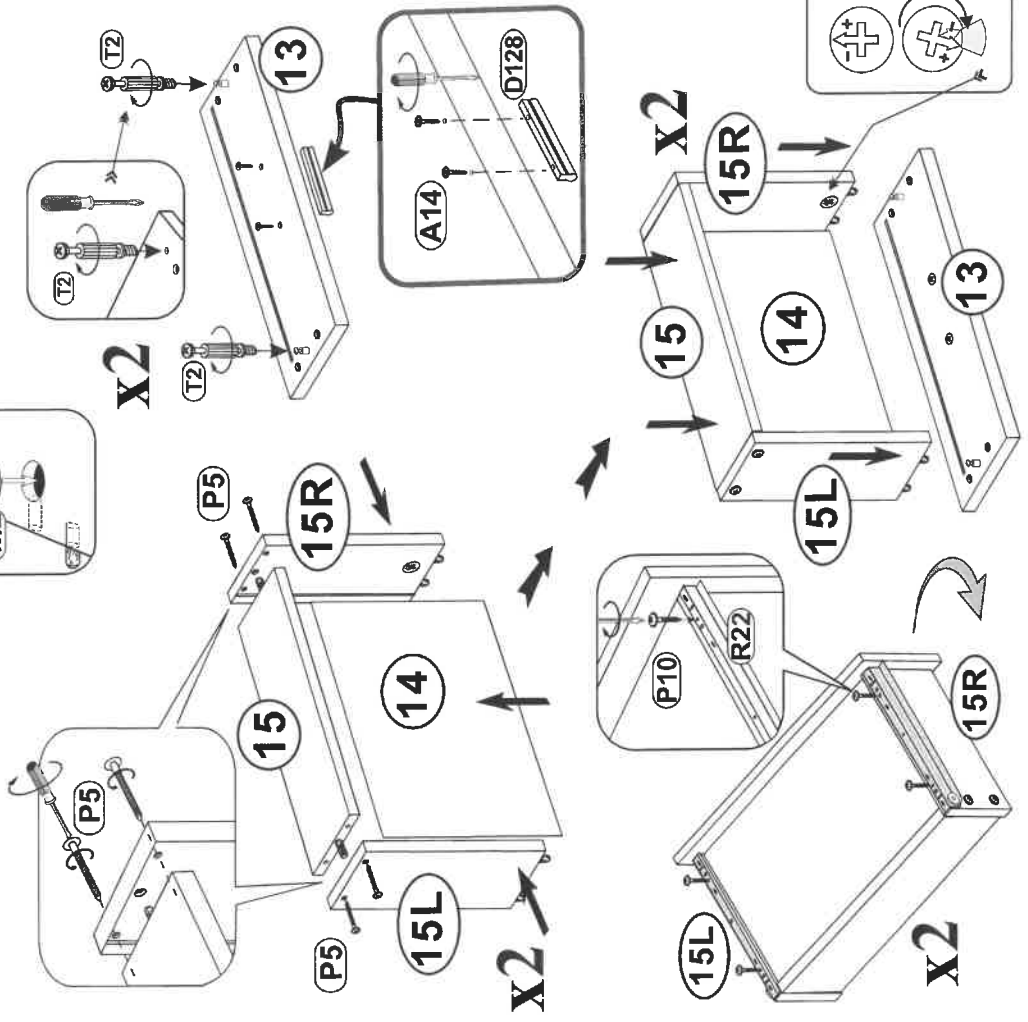
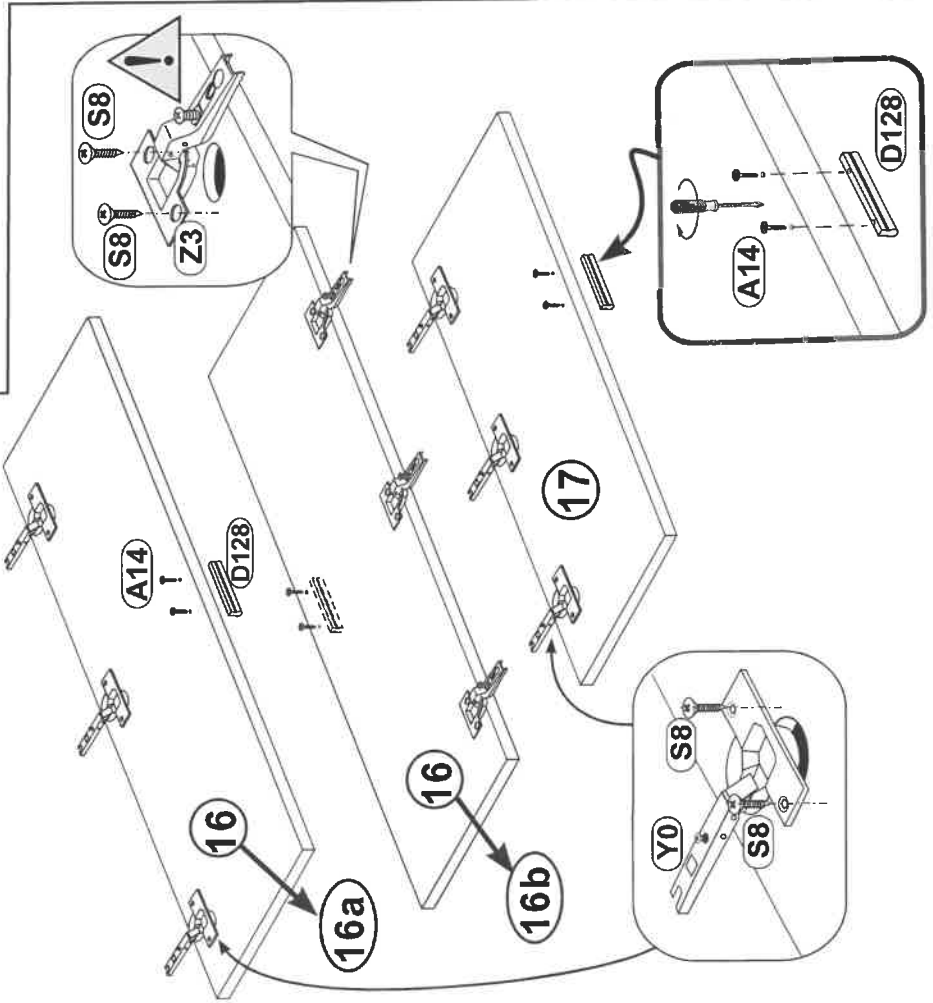
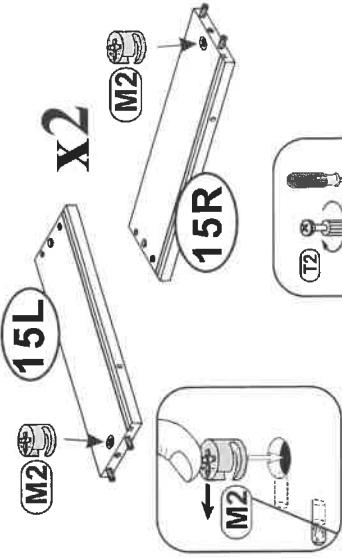
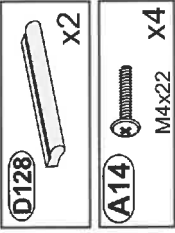
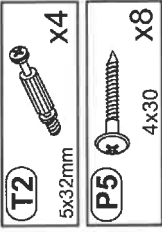
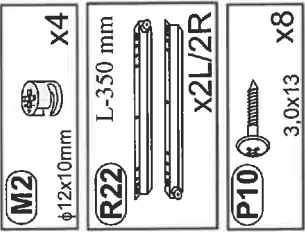
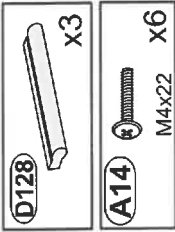
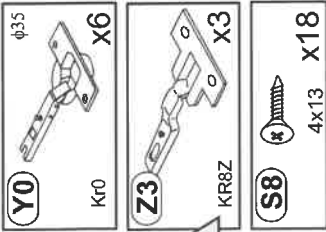

BLITZ II

Modellname:
Nazwa modelu:

Modellreihe:
Numer modelu:

Blatt Nr
Strona Nr

6/9

5

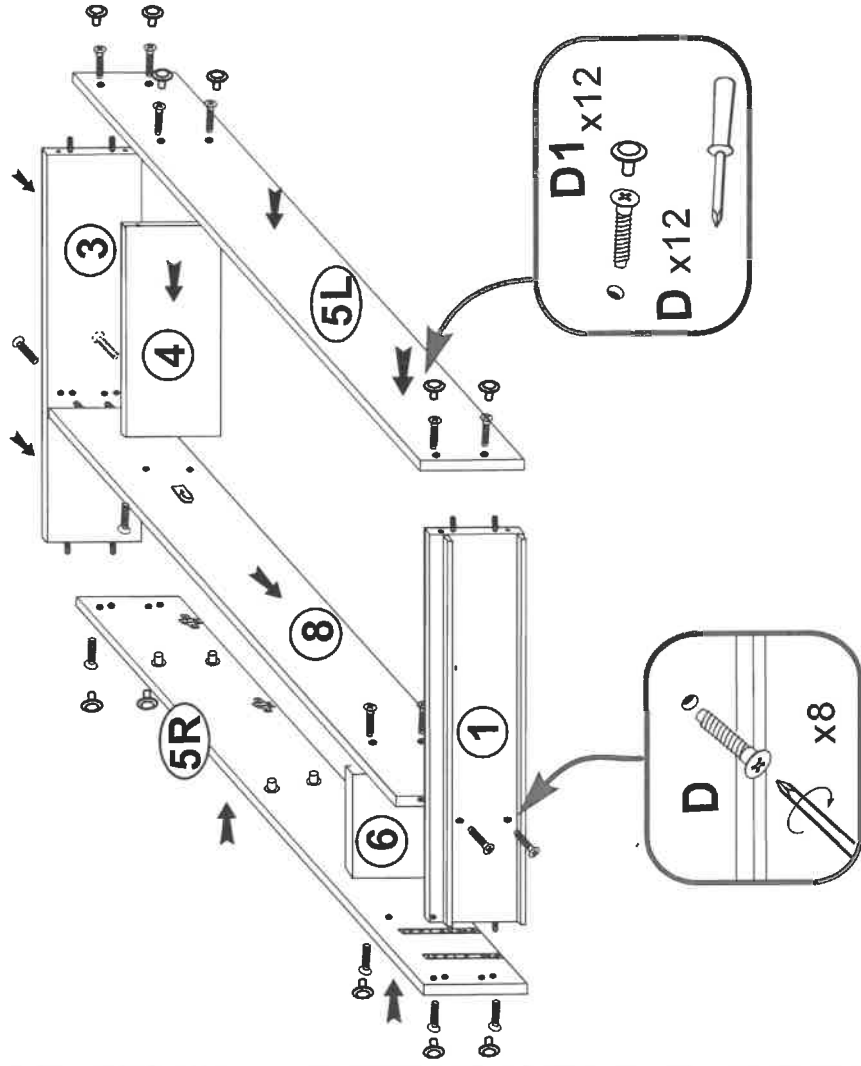

6

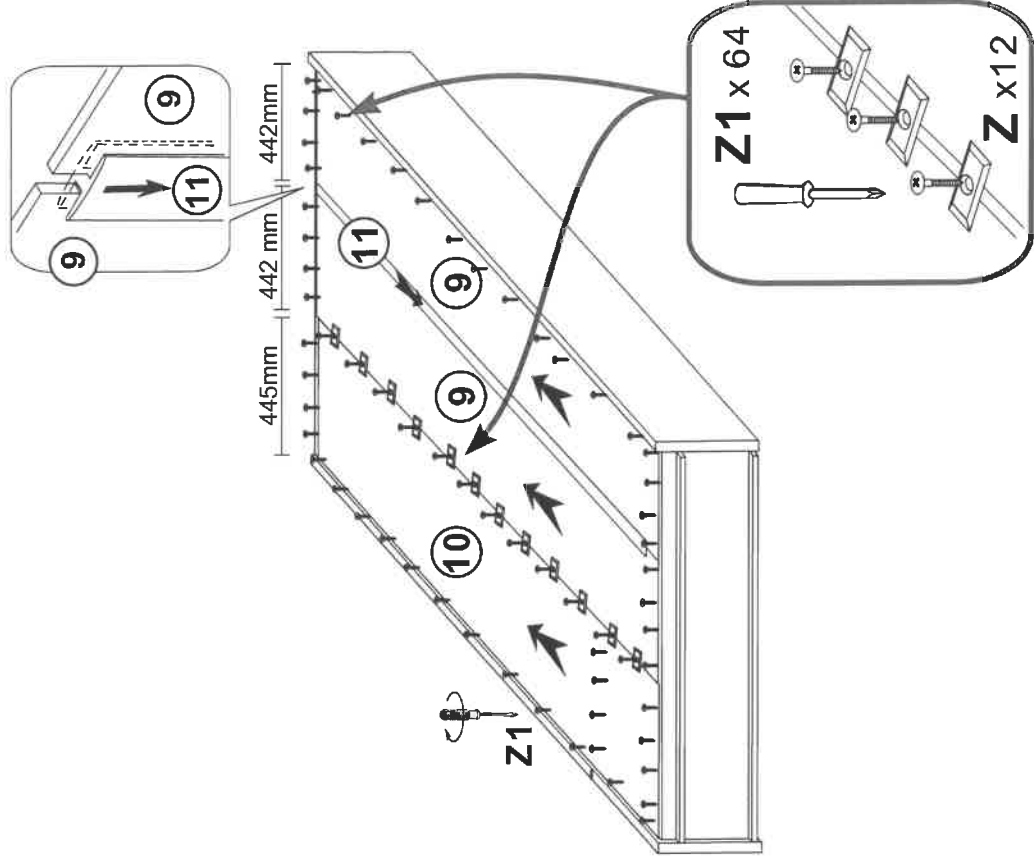
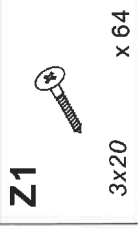
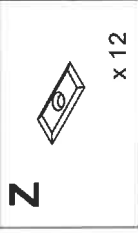

Modellname:
Nazwa modelu :

BLITZ II

Modellreihe: **8X--BL03**
Numer modelu:

Blatt Nr
Strona Nr

7/9

7

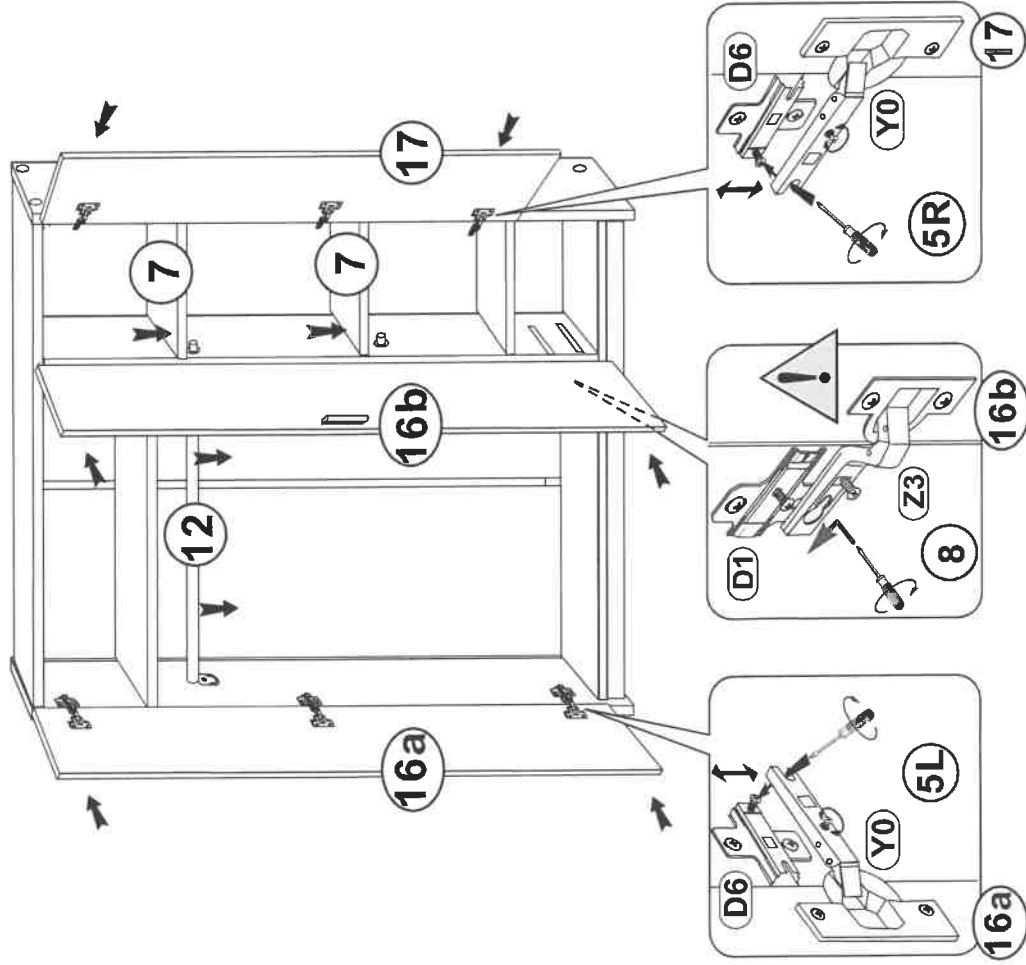

8

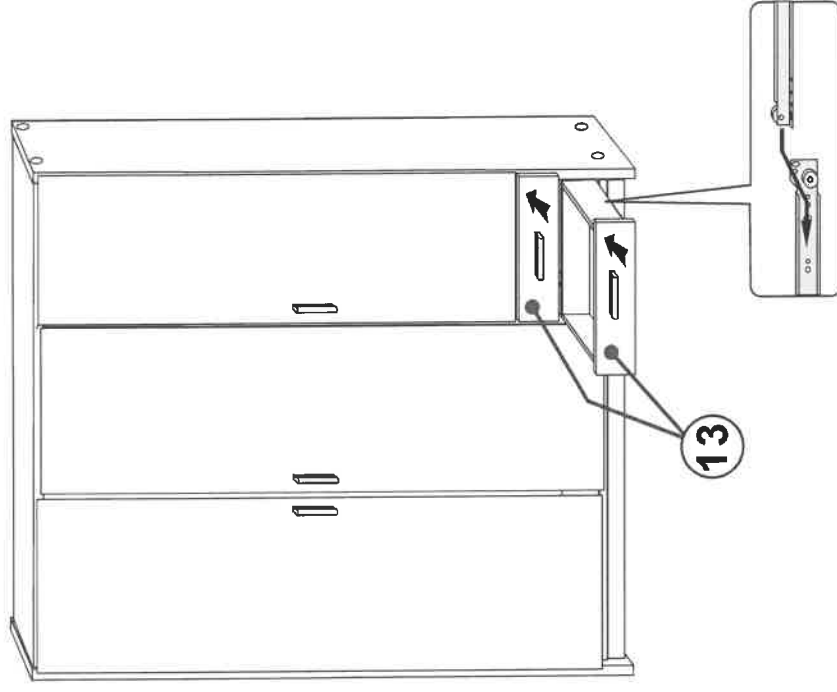

Verstellmöglichkeiten

- a) Fugenverstellung:
Befestigungsschraube "A" lockern, gewünschte Fuge mit Schraube "B" einstellen, Schraube "A" anziehen.
- b) Tiefenverstellung:
Befestigungsschraube "A" lockern, Bandarm nach vorne oder rückwärts verschieben, Schraube "A" anziehen, Schraube "B" mit einer 1/4 Drehung nach rechts arretieren.
- c) Höhenverstellung:
Befestigungsschraube "C" lockern, Höhe einstellen, schraube "C" anziehen.

Instructions for hinge adjustment

- a) Side adjustment:
Loosen fixing screw "A", adjust gap with screw "B" and retighten screw "A".
- b) Depth adjustment:
Loosen fixing screw "A", push hinge arm forwards or backwards, re-tighten screw "A", fix screw "B" with a 1/4-tur in clock-wise direction.
- c) Height adjustment:
Loosen screw "C", adjust height, re-tighten screw "C".

Możliwości regulacji

- a) Regulacja szczeliny:
Poluzować wkręt "A", wkrętem "B" ustawić odpowiednią szczelinę, dokręcić wkręt "A".
- b) Regulacja głębokości:
Poluzować wkręt "A" (1 obrót), ustawić głębokość, dokręcić wkręt "A".
- c) Regulacja wysokości:
Poluzować wkręt "C" (1 obrót), dokonać regulacji wysokości położenia drzwi, wkręt "C" dokręcić.

Instructies voor het bijstellen van de scharnieren

- a) Bijstellen in de breedte:
maak schroef "A" los en verbreed of versmal de tussenruimte met schroef "B".
Draai schroef "A" daarna teug vast.
- b) Bijstellen in de diepte:
maak schroef "A" los, duw de scharnierarm naar voor of naar achter, draai schroef "A" terug vast, draai schroef "B" een kwartslag in wijzerzin.
- c) Bijstellen in de hoogte:
maak schroef "C" los, pas de hoogte aan, draai schroef "C" terug vast.

Instructions de réglage des charnières

- a) Réglage en largeur:
dévisssez la vis "A" et augmentez ou réduisez l'écart avec la vis "B".
Reserrez la vis "A".
- b) Réglage en profondeur:
dévisssez la vis "A", avancez ou reculez la cheville de la charnière dans la platine de fixation, reserrez la vis "A" et serrez la vis "B" un quart de tour dans le sens des aiguilles d'une montre.
- c) Réglage en hauteur:
dévisssez la vis "C" adaptez la hauteur, reserrez la vis "C"

a)

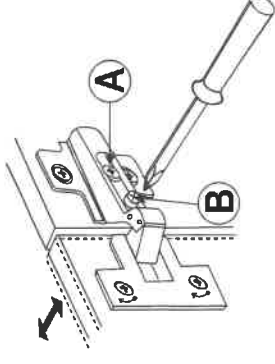

b)

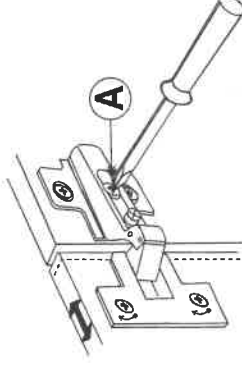

c)

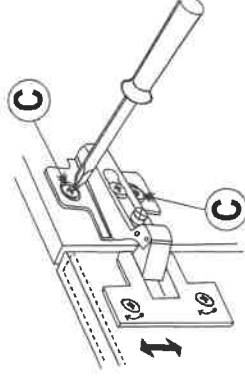

Modellname:
Nazwa modelu :

BLITZ II

Modellreihe: **8X--BL03**
Numer modelu:

Blatt Nr **9/9**
Strona Nr

Q



x 2

SCHRANKREGULIERUNG (EINSTELLUNG)
REGULACJA SZAFY PO ZŁOŻENIU

DREHTÜRENSCHRANK
SZAFAZ DRZWIAMI OTWIERANYMI

