

# MILV02

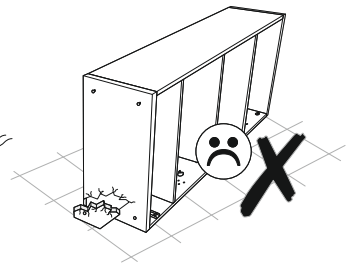
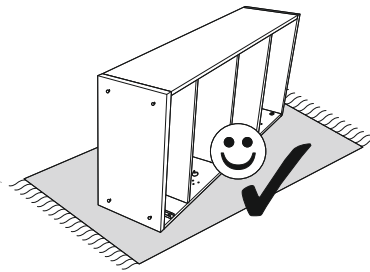
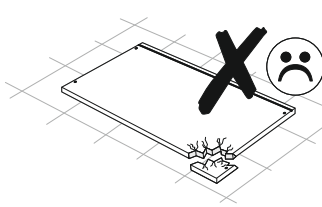
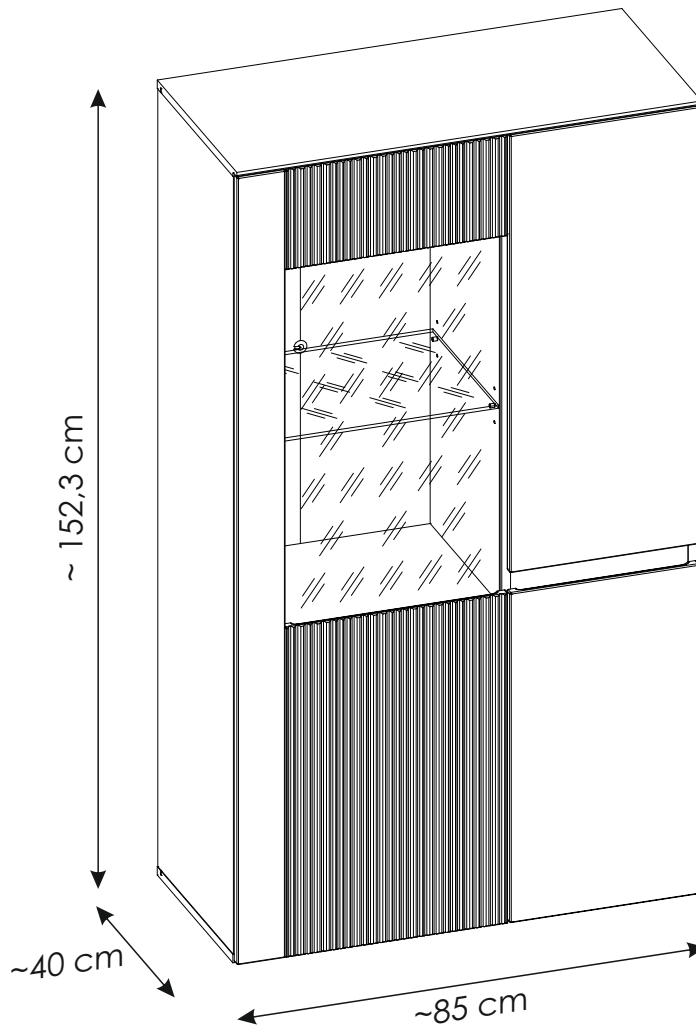
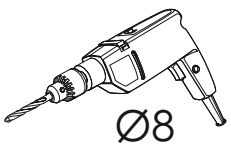
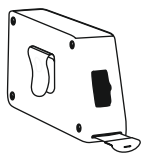
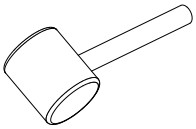
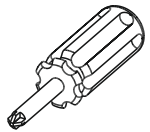
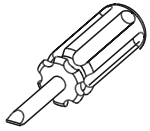

**ملاحظة!**

يجب تثبيت الأثاث بإحكام إلى الحائط أو الجدار لتجنب خطر إنقلابه. تحتوي العلبة على مسامير التثبيت التي تناسب الجدران الخرسانية أو الطوب. إذا كان جدارك مصنوعاً من مادة مختلفة أو لم تكن متأكدًا من مادة بناءه أسأل المتخصص عن كيفية التثبيت.

PL.

UWAGA! Mebel należy trwale zamocować do ściany, aby uniknąć ryzyka związanego z przewróceniem się mebla. W paczce znajdują się elementy mocujące odpowiednie wytycznie do ścian betonowych lub z pełnej cegły. Jeśli Twoja ściana wykonana jest z innego materiału lub nie masz pewności co do budowy tej ściany, skonsultuj się w kwestii montażu ze specjalistą.

D.

ACHTUNG! Um alle mit dem Umkippen des Möbels verbundenen Risiken auszuschließen, muss das Möbel fest an der Wand verankert werden. Die im Paket enthaltenen Beschläge für die Wandbefestigung sind ausschließlich für Wände aus Beton oder Vollziegel geeignet. Sollten die heimischen Wände aus anderem Baumaterial bestehen oder sollte es Zweifel in Hinsicht auf dieses Baumaterial geben, bitte eine Fachkraft zu Rate ziehen.

FR.

ATTENTION! Ce meuble doit être fixé en permanence au mur pour éviter les risques de chute. L'ensemble comprend des moyens de fixation adaptés uniquement aux murs de béton ou de brique. Si votre mur est fait d'un matériau différent ou si vous êtes incertain quant à la construction du mur, consultez un spécialiste.

I.

ATTENZIONE! Il mobile deve essere permanentemente fissato alla parete per evitare i rischi derivanti da un ribaltamento del mobile. La confezione contiene solo elementi di fissaggio adatti per pareti in calcestruzzo o in laterizio pieno. Se la vostra parete è realizzata in materiale diverso o avete dubbi sulla costruzione della parete, consultare uno specialista per un montaggio corretto.

RU.

ПРИМЕЧАНИЕ! Эту мебель необходимо всегда прикреплять к стене, чтобы избежать рисков, связанных с переворотом мебели. В пакете находятся крепительные элементы, которые подходят исключительно к бетонным стенам или из целого кирпича. Если стена изготовлена из другого материала или Вы не уверены относительно строения стены, проконсультируйтесь относительно монтажа со специалистом.

EN.

WARNING! To prevent this furniture from tripping over, fix it to the wall permanently. The package includes fastening elements only suitable for concrete or full-brick walls. If your wall is made of a different material or you are unsure as to the construction of the wall, please consult a specialist regarding installation.

SK.

POZOR! Nábytok musí byť trvalo pripevnený k stene tak, aby sa zamedzilo riziku prevrátenia. V balíku sa nachádzajú upevňovacie komponenty výlučne pre betónové steny alebo steny z plnej tehly. Ak je Vaša stena z iného materiálu alebo ak si nie ste istí, z čoho je stena vyhotovená, vyžiadajte si odbornú pomoc.

CZ.

POZOR! Nábytek je nutné pevně připevnit ke zdi, abychom se vyhnuli riziku spojenému s jeho převrnutím. V balíčku se nacházejí připevňující prvky vhodné výhradně do betonových zdí nebo zdí z plných cihel. Pokud jsou Vaše zdi zhotoveny z jiného materiálu nebo si nejste jejich konstrukcí jisti, konzultujte otázku montáže se specialistou.

RO.

ATENȚIE! Mobila trebuie ancorată permanent în perete pentru a evita riscul de răsturnare a mobilei. Pachetul conține elementele de fixare potrivite numai pentru pereții din beton sau din cărămidă solidă. Dacă peretele Dvs. este realizat dintr-un alt material sau nu sunteți sigur care este structura peretelui, consultați un specialist în privința montajului.

NL.

OPMERKING! De meubelen moeten permanent aan de muur worden bevestigd om te voorkomen dat de meubelen kantelen. Het pakket bevat bevestigingselementen die alleen geschikt zijn voor betonnen of massieve bakstenen muren. Als uw muur van een ander materiaal is gemaakt of als u niet zeker bent over de constructie van deze muur, raadpleeg dan een specialist voor de installatie.

TR.

DİKKAT! Devrilmeye riskini önlemek için mobilya duvara sabitlenmelidir. Pakette, sadece beton veya tam tuğla duvarlara uygun sabitleme elemanları bulunmaktadır. Eğer duvarınız başka bir malzemedir yapıldıysa veya duvar yapısından emin değilseniz, montaj konusunda bir uzmana danışınız.

E.

¡ATENCIÓN! El mueble debe ser fijado permanentemente a la pared para evitar el riesgo relacionado con el vuelco del mueble. En el paquete hay elementos de fijación adecuados solo para paredes de hormigón o de ladrillo entero. Si su pared está hecha de otro material o no está seguro sobre la construcción de esta pared, consulte el montaje con un especialista.

CN.

注意！本家具需要固定在墙上以免倒塌。  
本包所含有的固定部件仅适用于混凝土墙及整砖墙。  
欲使用在其他墙体或不确定墙体时，  
请向专家询问安装方式。

HR.

NAPOMENA! Namještaj mora biti trajno pričvršćen za zid, kako bi se izbjegao rizik od njegova prevrtanja. U paketu se nalaze elementi za pričvršćivanje prikladni isključivo za betonske zidove ili punu ciglu. Ako je Vaš zid izrađen od drugog materijala ili niste sigurni od čega je napravljen Vaš zid, konzultirajte se sa stručnjakom u vezi sa montažom.

SLO.

POZOR! Pohištvo trajno pritrdite na steno, da preprečite tveganje, da se prevrne. V paketu so pritrdilni elementi, ki so ustrezni izključno za betonske stene in za stene iz polne opeke. Če je vaša stena izdelana iz drugih materialov ali niste gotovi glede konstrukcije stene, se o montaži posvetujte s strokovnjakom.

HU.

FIGYELEM! Rögzítse a bútorokat a falhoz, hogy elkerülje a bútor felborulásának kockázatát. A készletben kizárólag beton- vagy téglafalhoz használható kötőelemek találhatók. Ha a fal más anyagból készült, vagy ha nem tudja, milyen falak találhatók otthonában, forduljon szakemberhez.





version A



version B

**Bx**

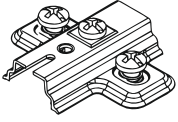

**Bx**

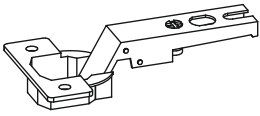

**Bx + Bx**

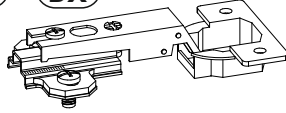



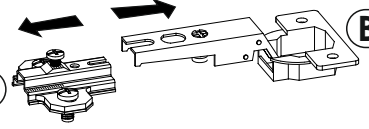





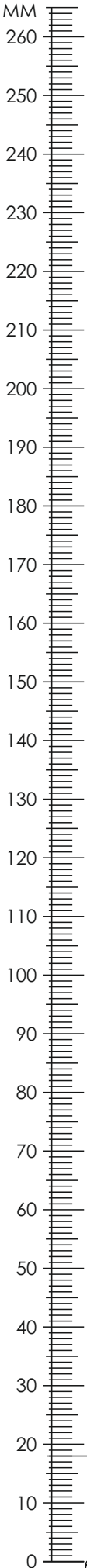



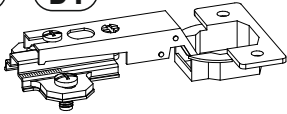

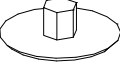

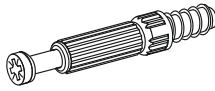
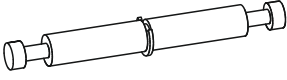
**Bx**

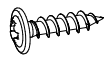

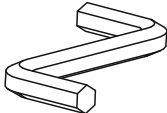
**Bx**

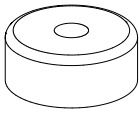
# MILV02

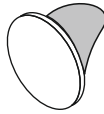
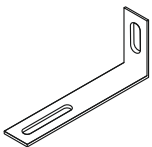
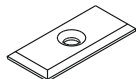

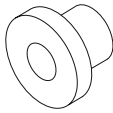
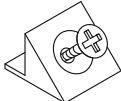
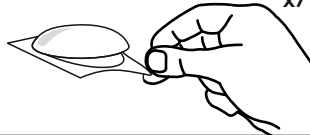
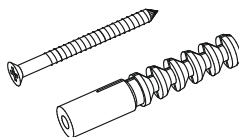
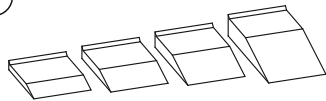
<b>A1</b> 8 x 35 mm x22 	<b>A8</b> 6 x 45 mm x3 	<b>B0 + B1</b>  x7
<b>C2</b> 5 x 13 mm x14 	<b>D2</b>  x20	<b>E0</b> Ø16 x14 
<b>E1</b> 15 x 12 mm x16 	<b>E4</b> 12 x 10 mm x10 	<b>F1</b> 6 x 34 mm x16 
<b>F3</b> 7 x 64 mm x5 	<b>G1</b> 7 x 50 mm x6 	<b>I2</b> 4 x 16 mm x6 
<b>I3</b> 3.5 x 22 mm x5 	<b>M</b>  x1	<b>N1</b> 3 x 16 mm x15 
<b>O1</b>  x5	<b>P15</b>  x2	<b>P17</b>  x10 Ø20
<b>Q9</b>  x2	<b>R1</b>  x12	<b>R2</b>  x2
<b>R3</b>  x4	<b>R4</b>  x11	<b>R8</b>  x7
<b>S13</b>  x2 Ø8	<b>Z</b>  x1	

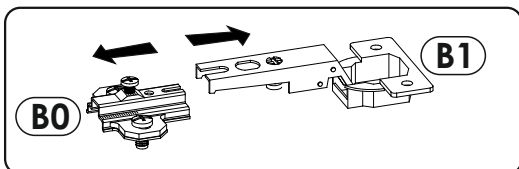

# MILV02

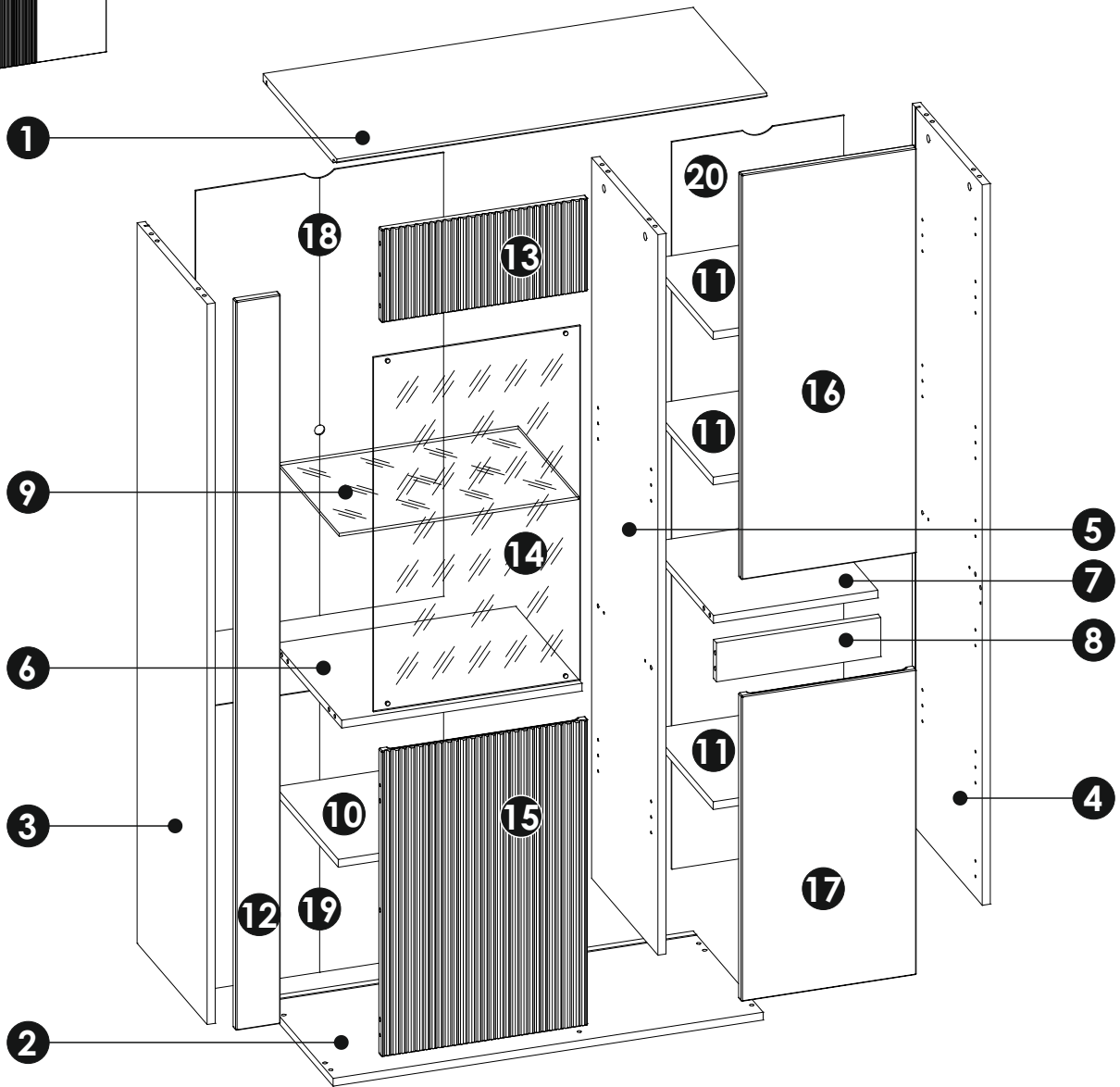
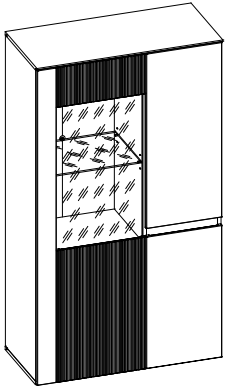

<b>1</b>	850	400	16	x1	1/2
<b>2</b>	850	380	16	x1	1/2
<b>3</b>	1476	380	16	x1	2/2
<b>4</b>	1476	380	16	x1	2/2
<b>5</b>	1476	360	16	x1	2/2
<b>6</b>	475	360	16	x1	1/2

<b>7</b>	325	343	16	x1	2/2
<b>8</b>	325	80	16	x1	2/2
<b>9</b>	474	330	6	x1	1/2
<b>10</b>	474	340	16	x1	1/2
<b>11</b>	324	340	16	x3	2/2
<b>12</b>	1494	88	16	x1	2/2
<b>13</b>	190	408	16	x1	1/2

<b>14</b>	726	409	4	x1	1/2
<b>15</b>	626	408	16	x1	1/2
<b>16</b>	830	346	16	x1	1/2
<b>17</b>	626	346	16	x1	1/2
<b>18</b>	909	490	3	x1	2/2
<b>19</b>	579	490	3	x1	2/2
<b>20</b>	1490	340	3	x1	2/2

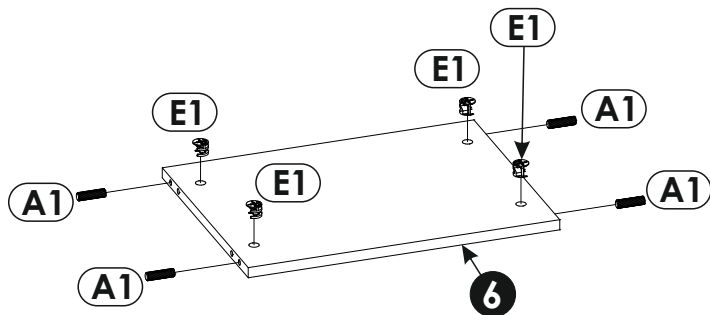
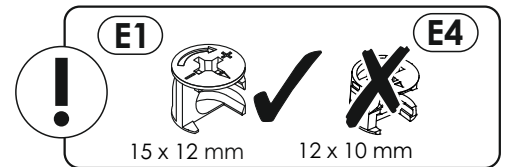
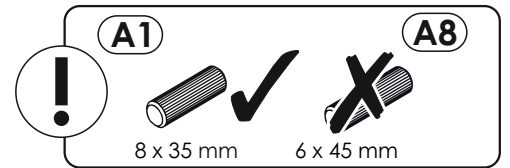
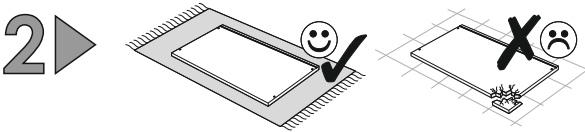
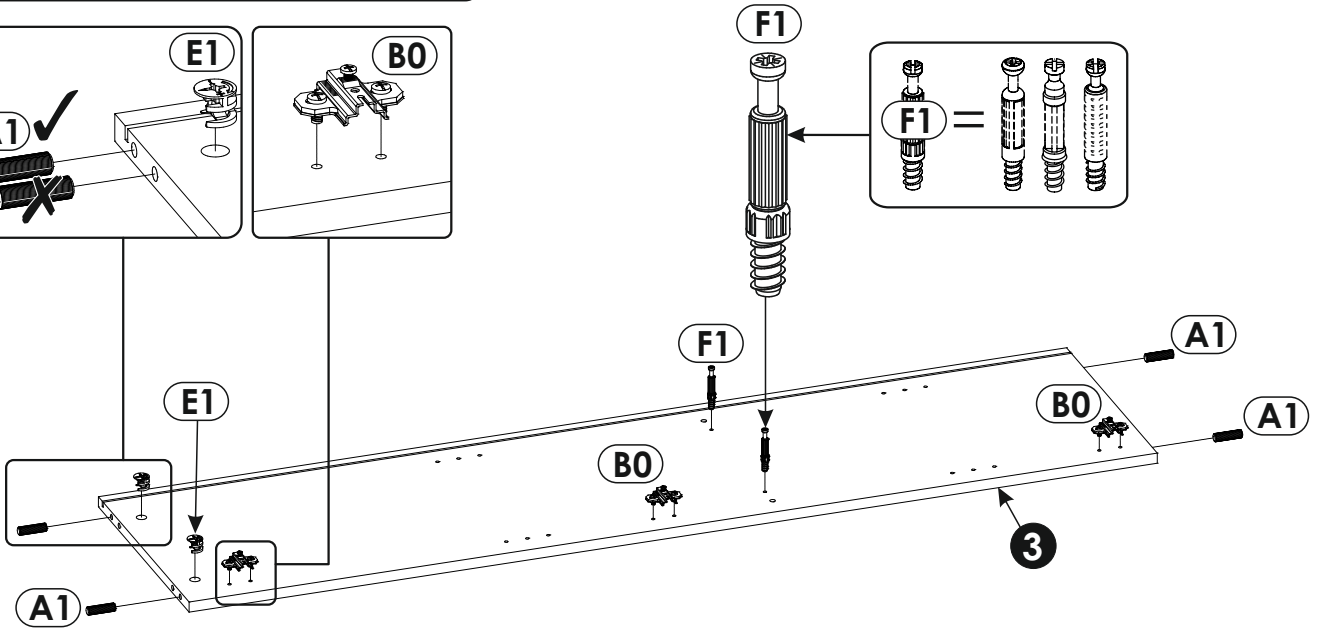
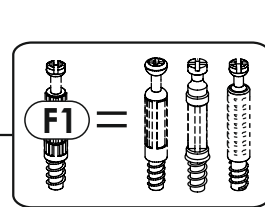
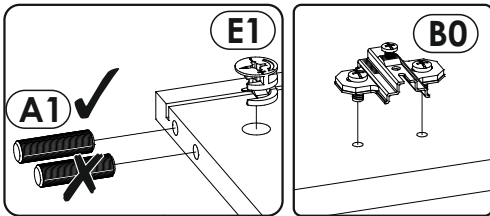
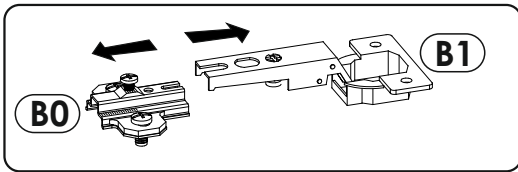
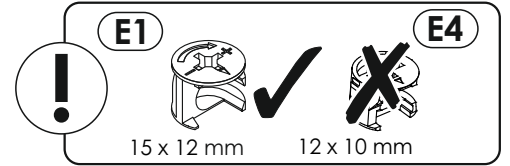
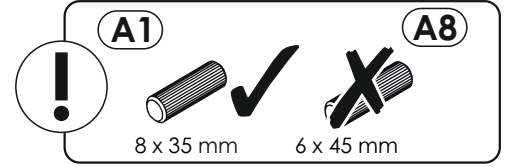
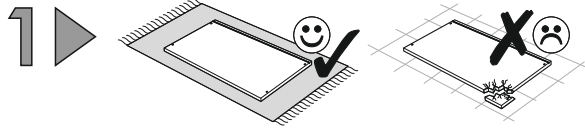
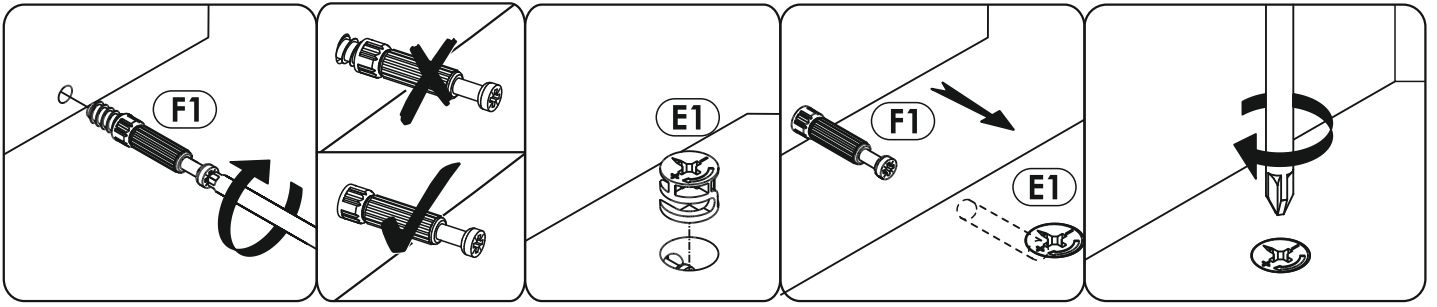

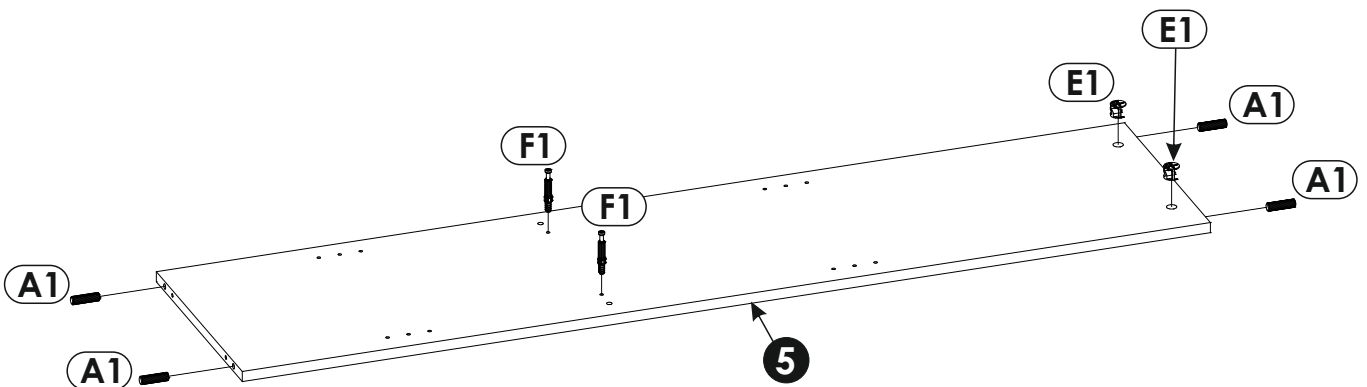
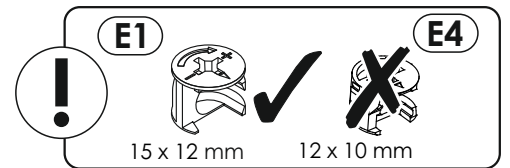
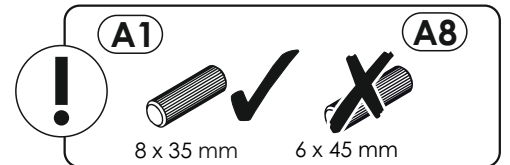
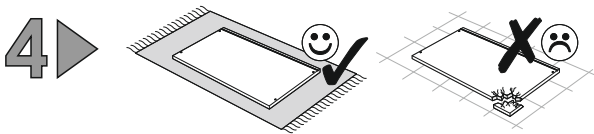
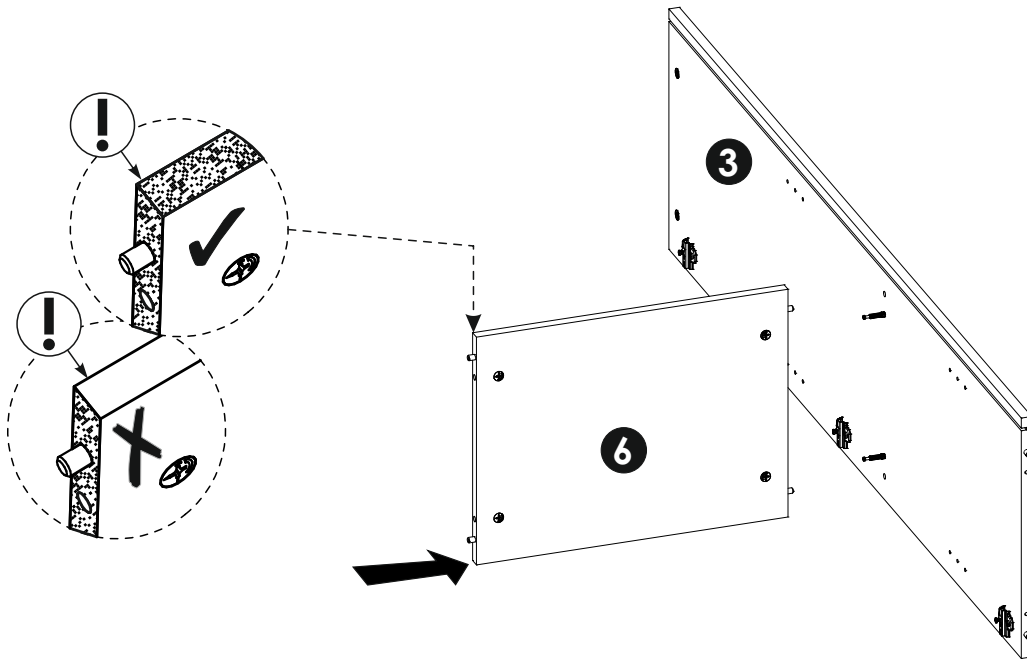
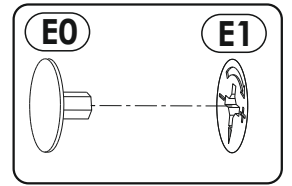
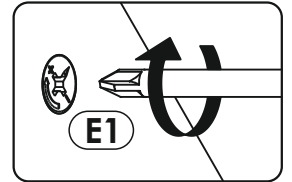
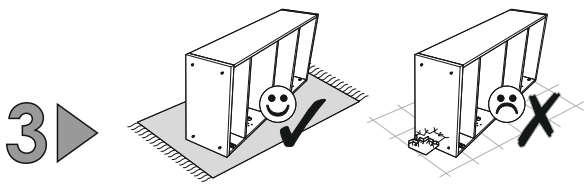



5 ▶

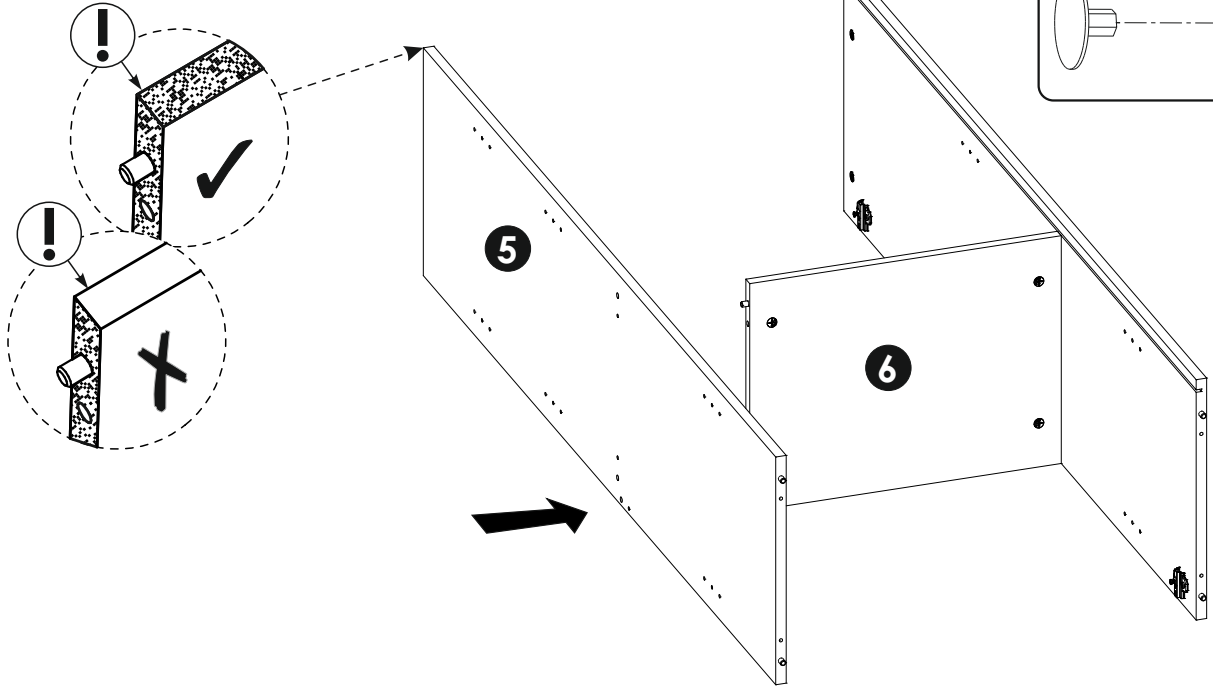
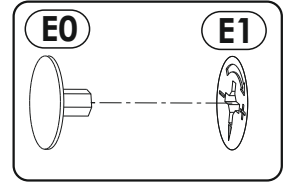
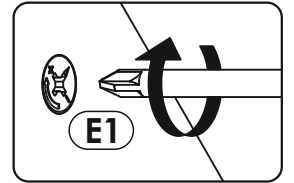
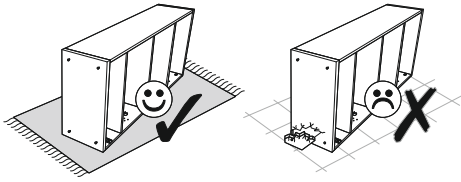

6 ▶

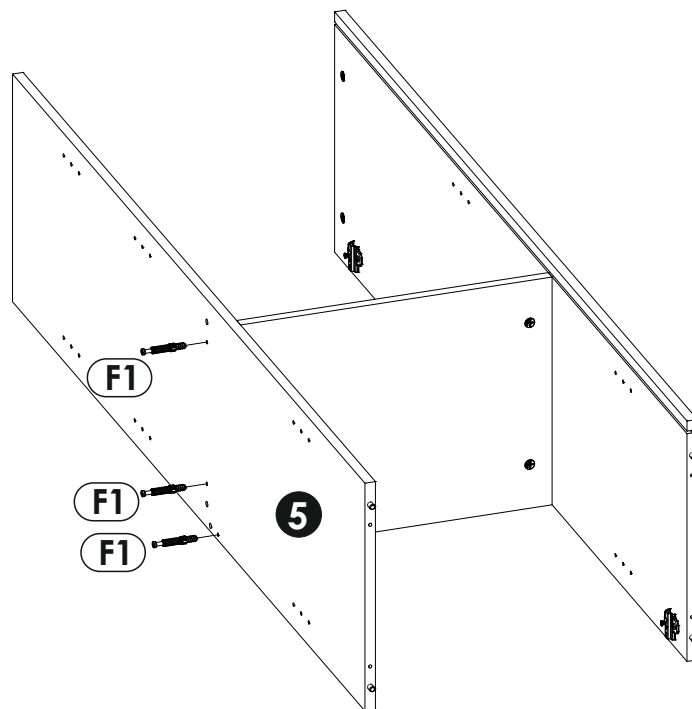
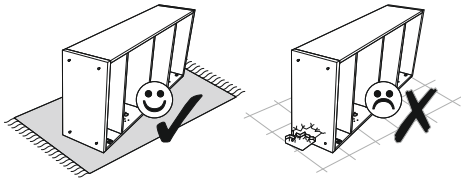

7 ▶

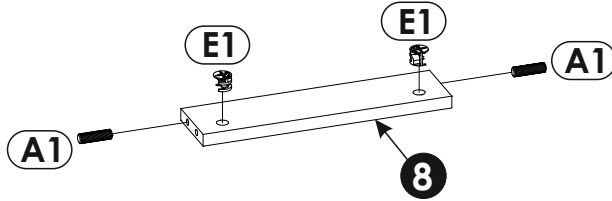
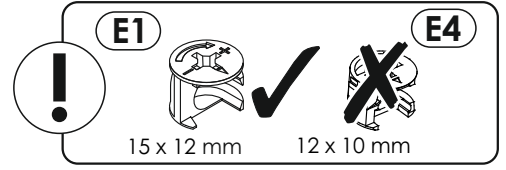
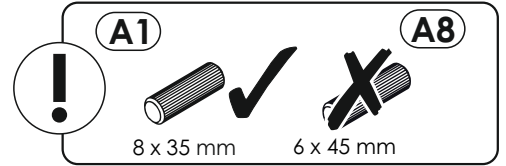
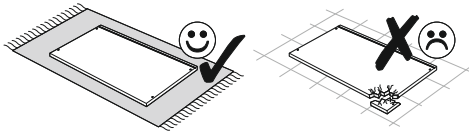

8 ▶

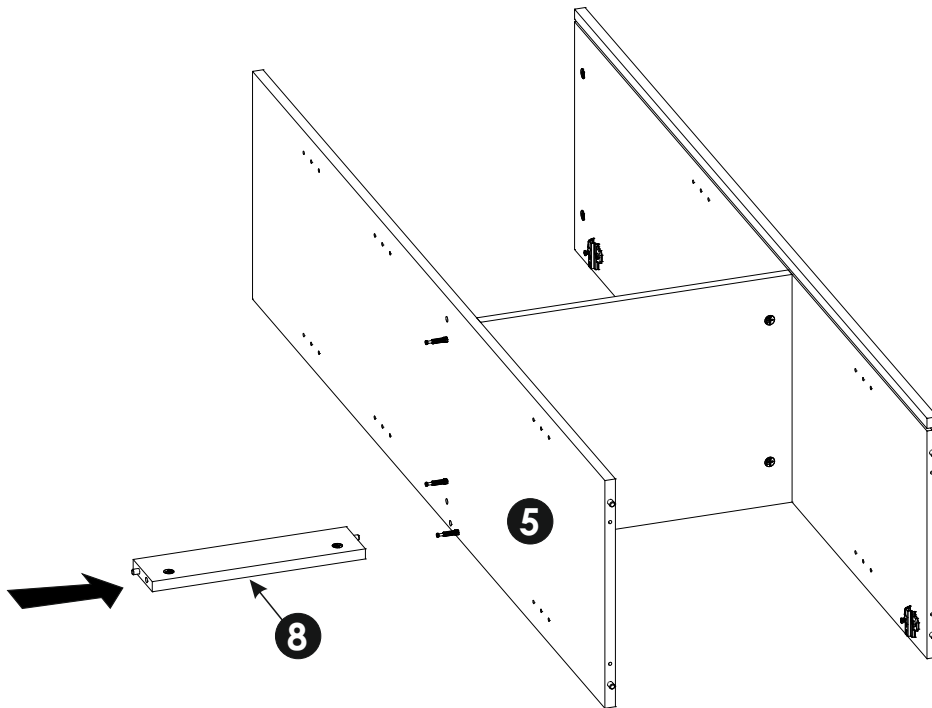
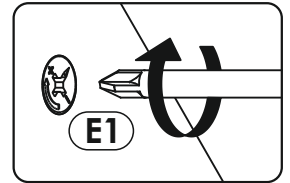
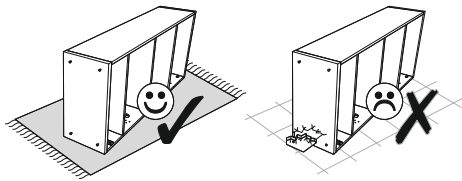

9 ▶

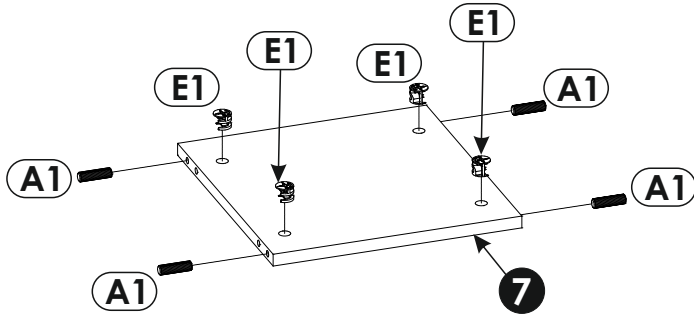
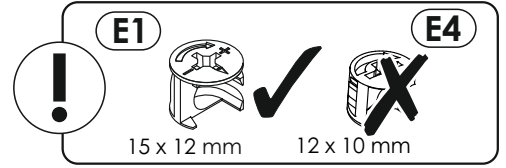
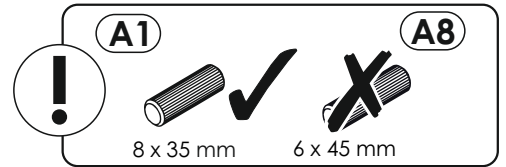
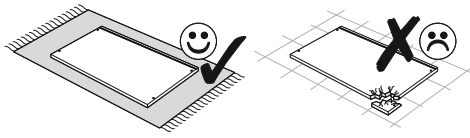

10 ▶

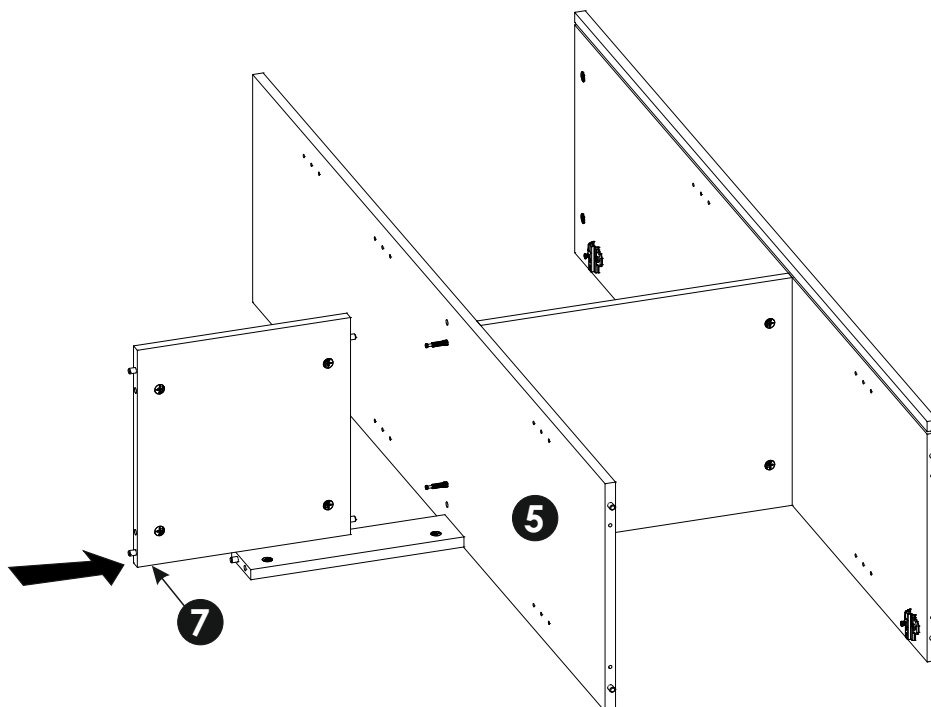
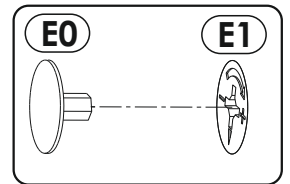
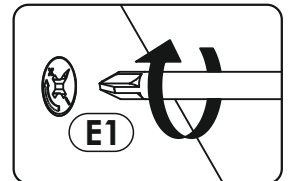
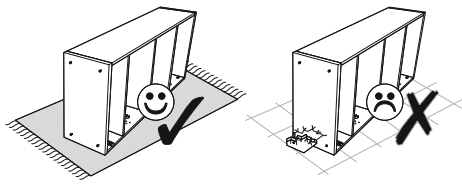

11 ▶

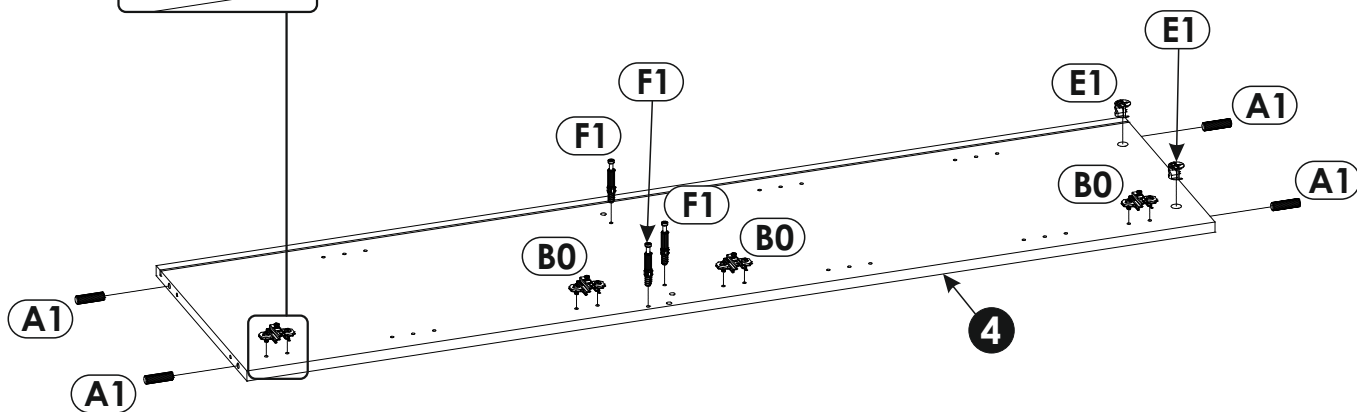
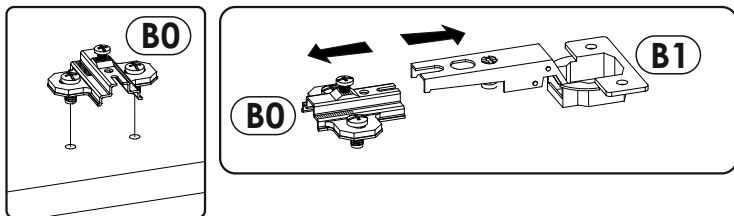
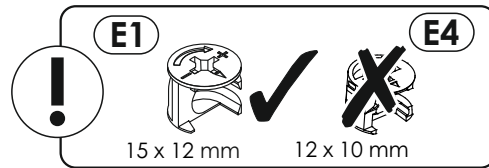
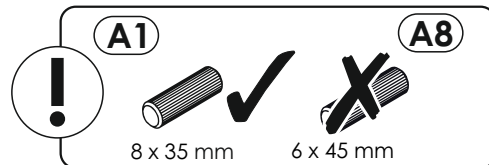
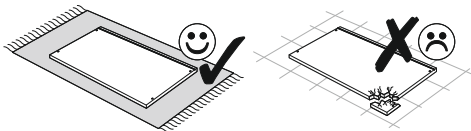

12 ▶

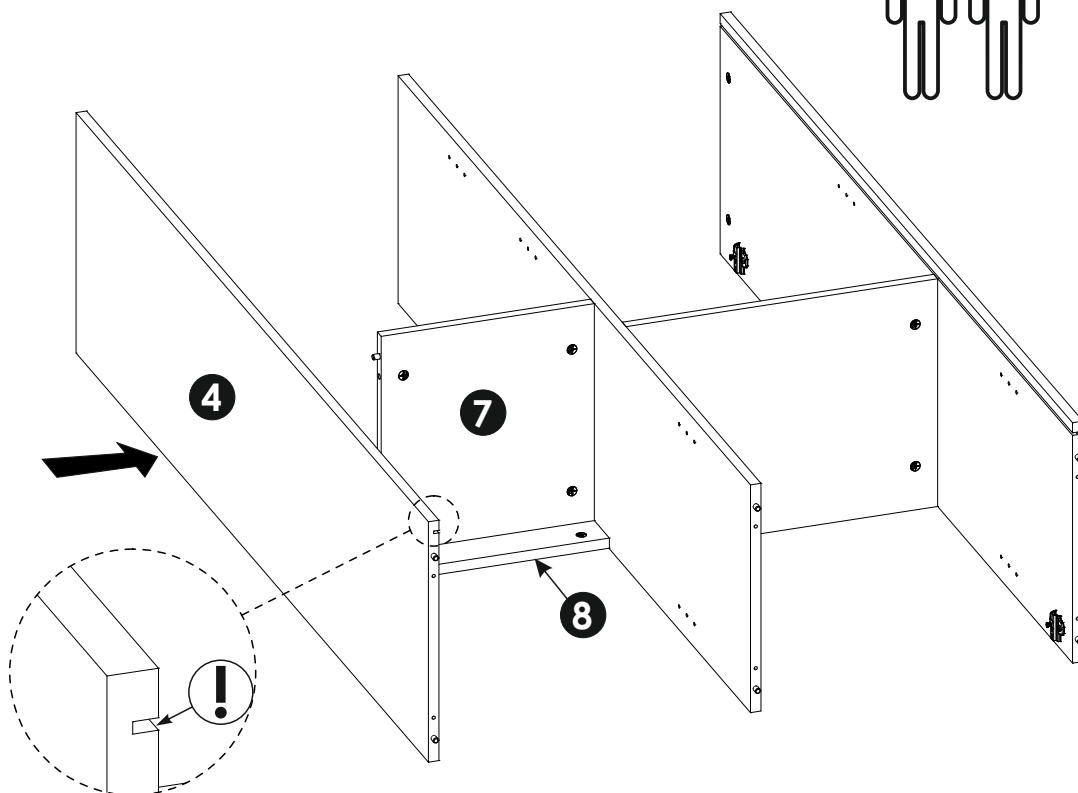
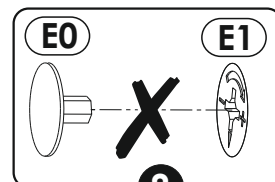
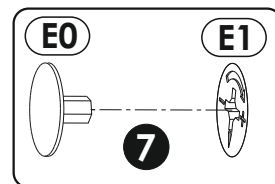
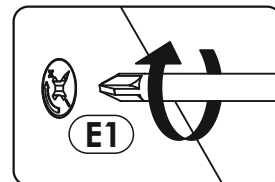
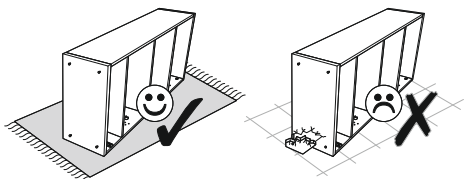

13▶

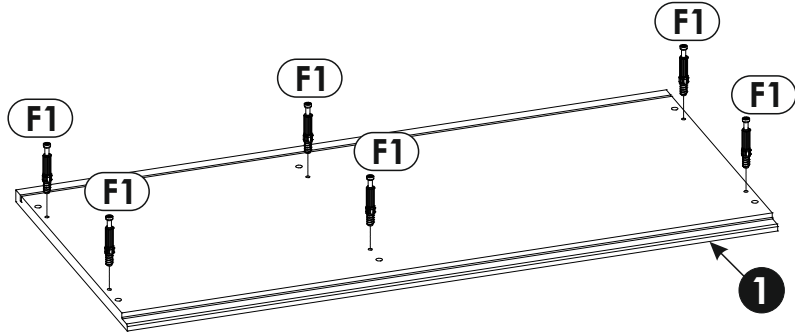
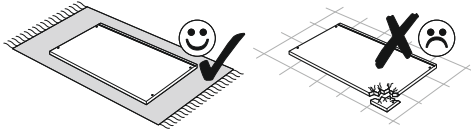

14▶

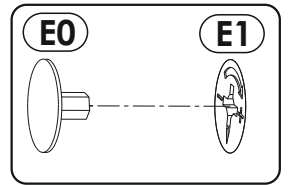
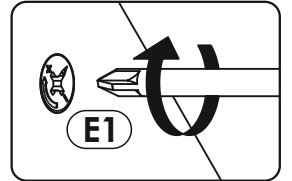
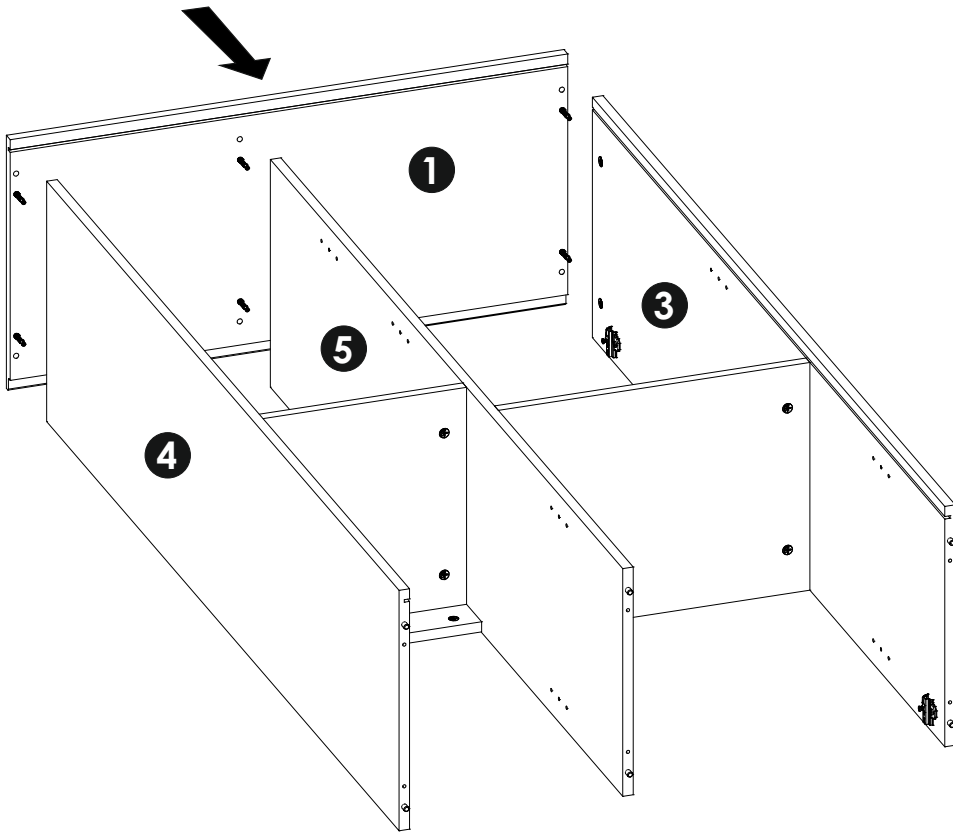
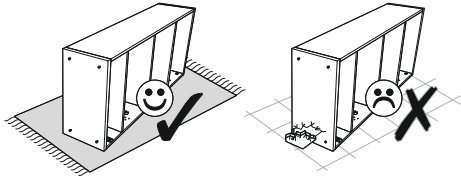

15 ▶

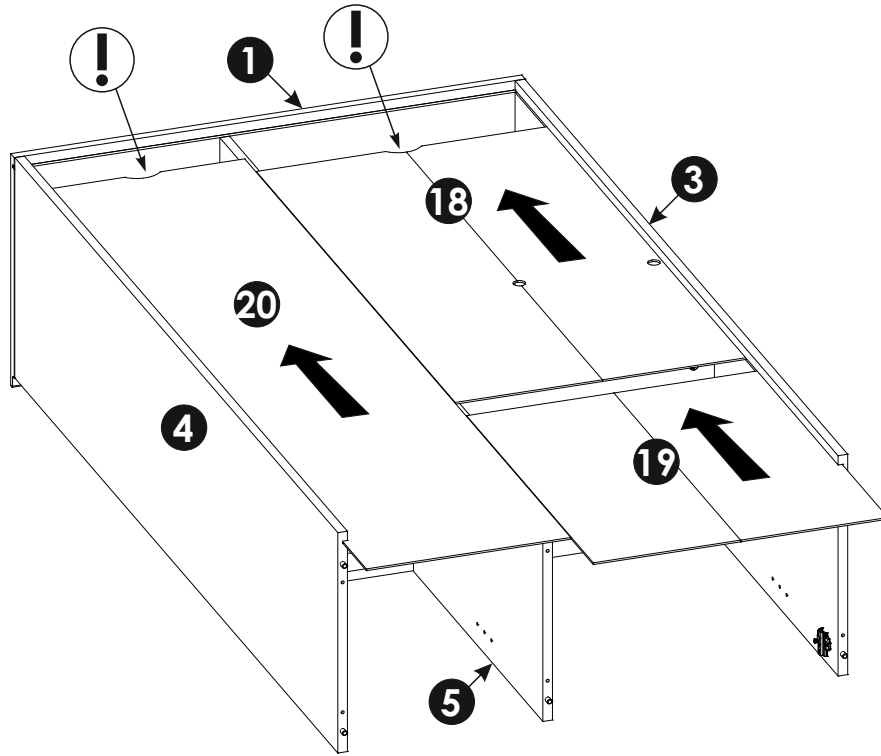
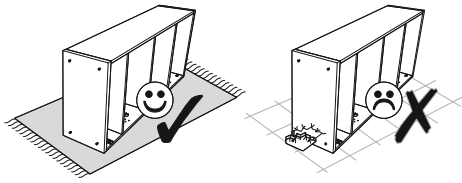

16 ▶

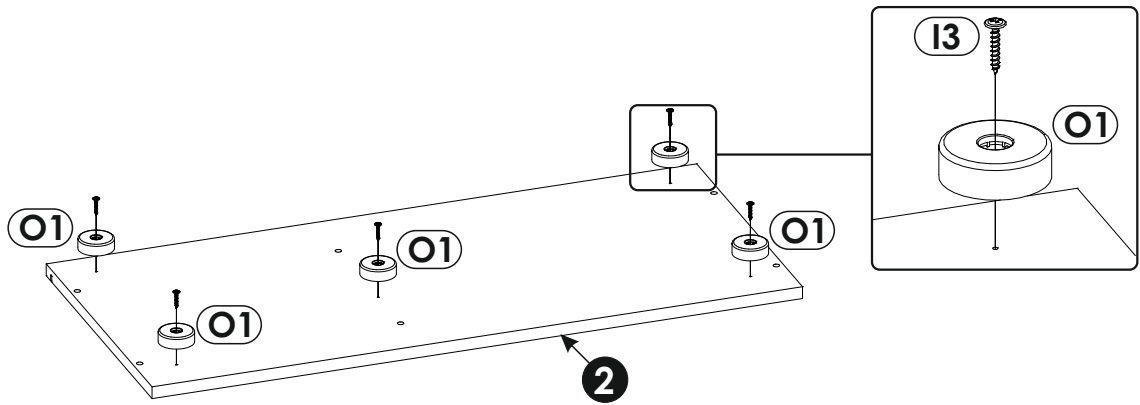
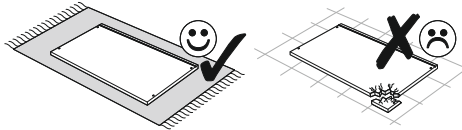

17 ▶

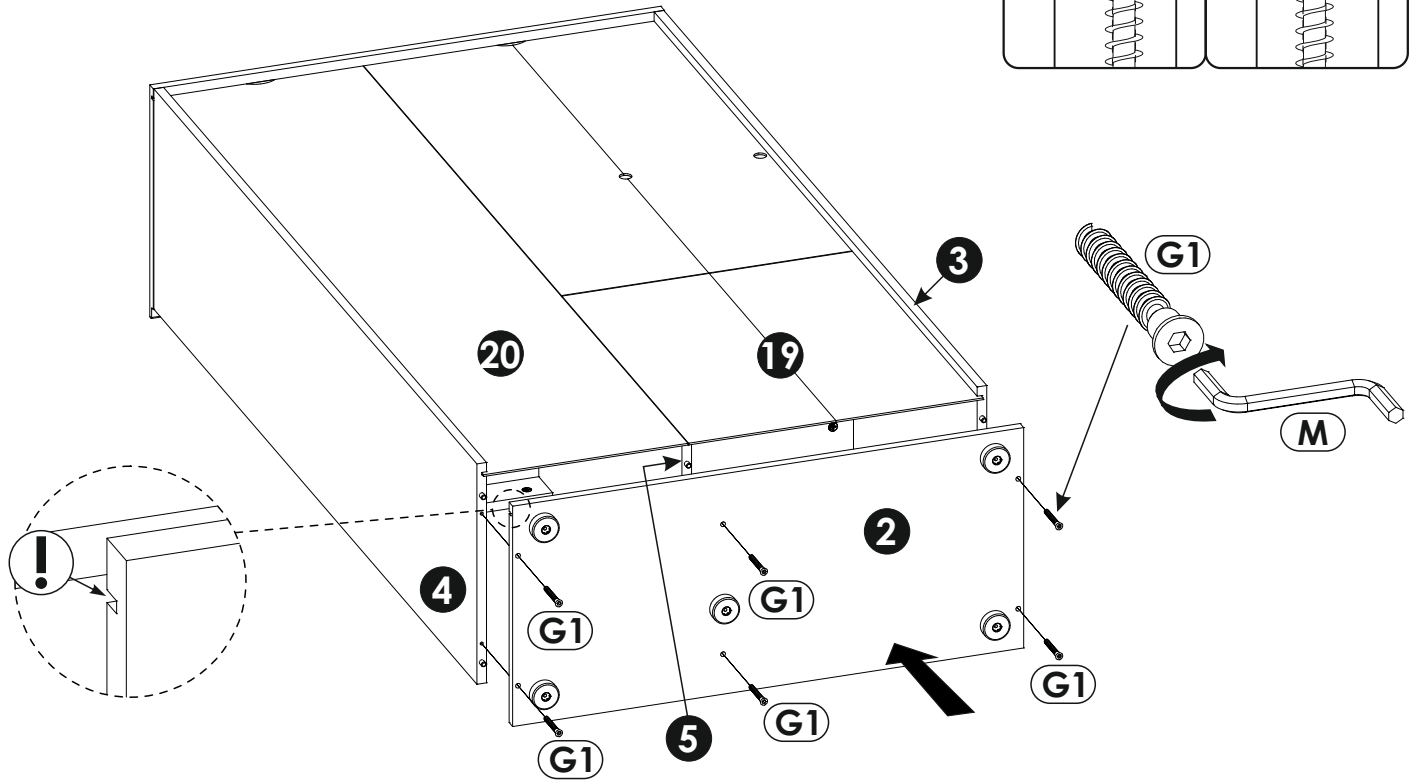
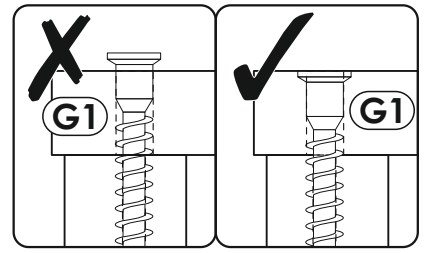
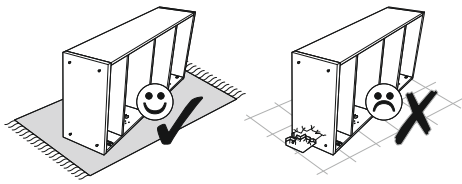

18 ▶

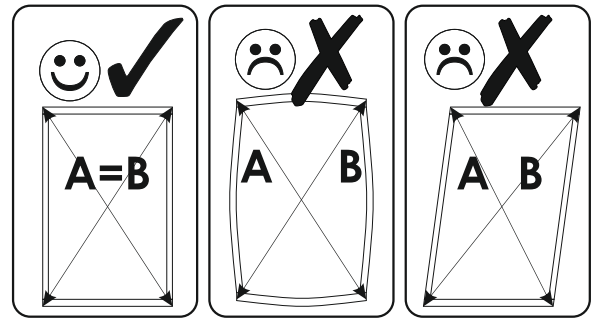
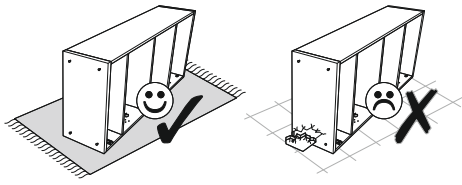

**A=B**

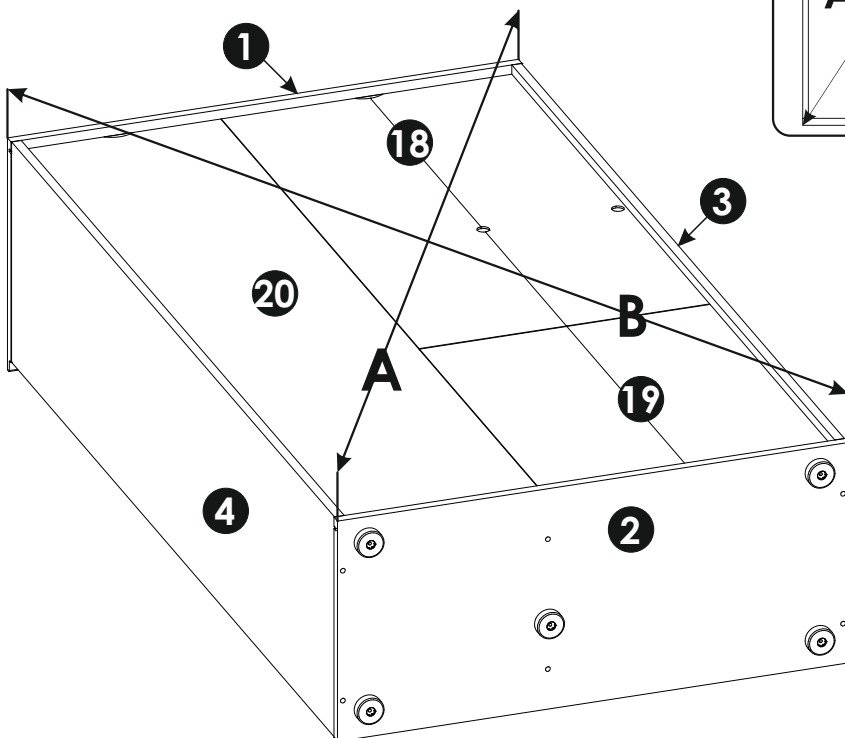

19 ▶

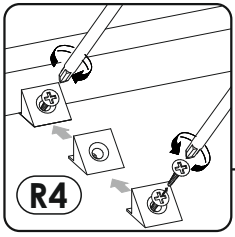
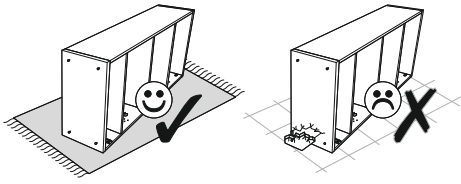

x11

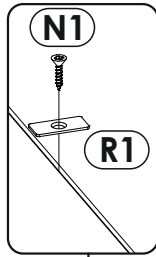

x9

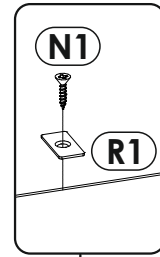

x3

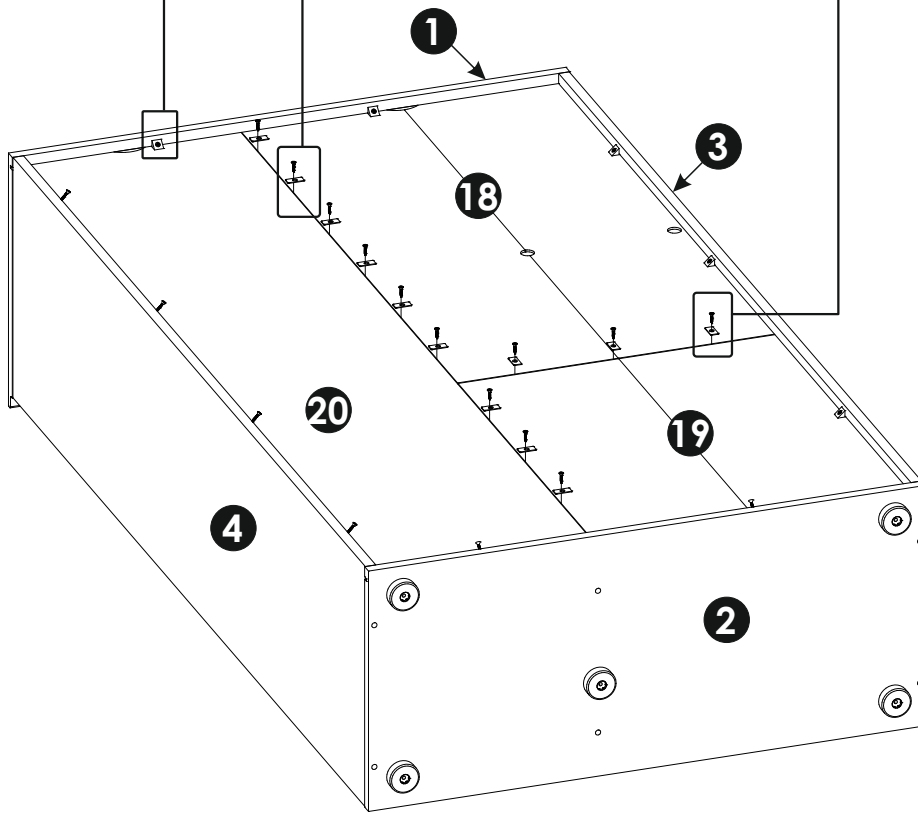



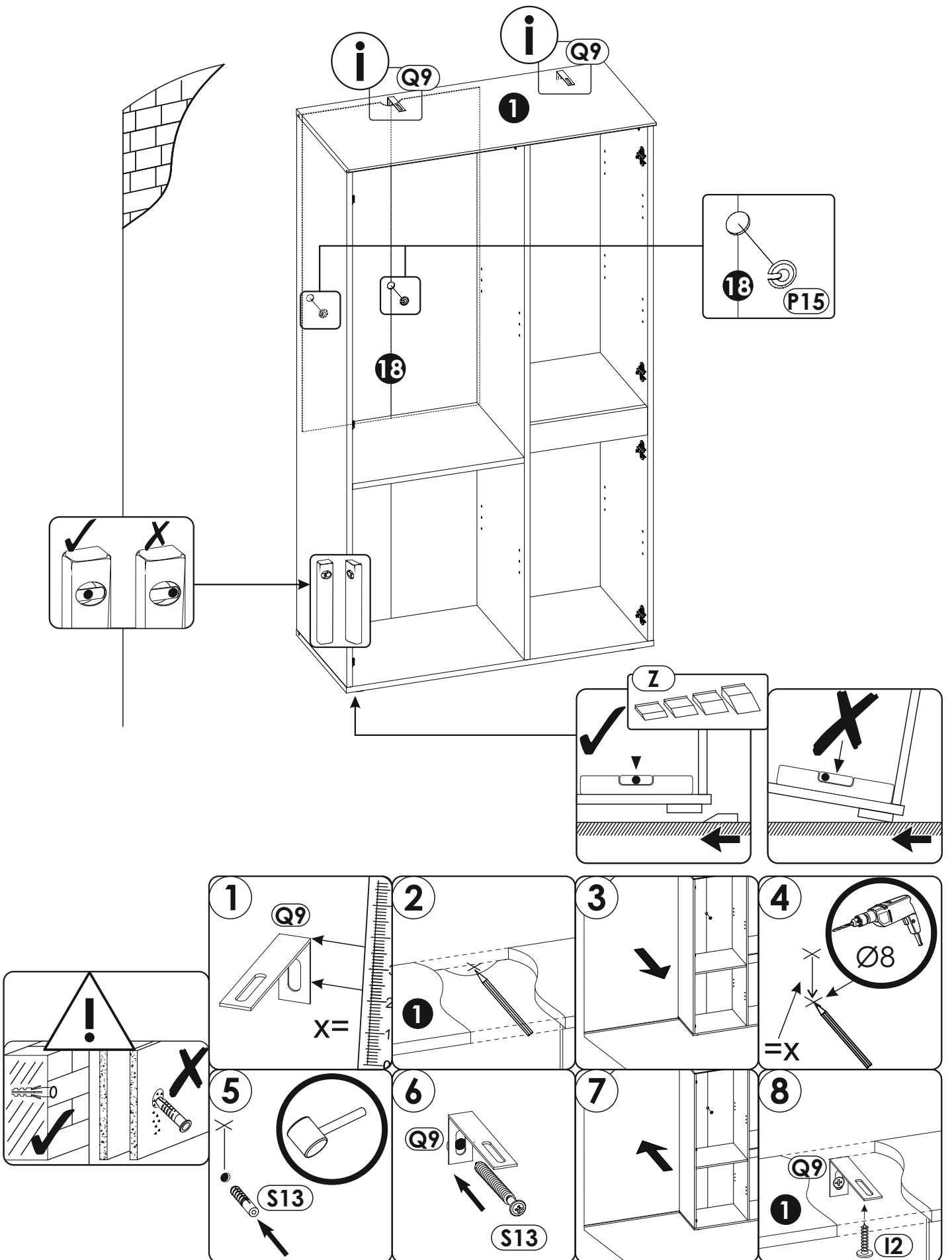

21 ▶

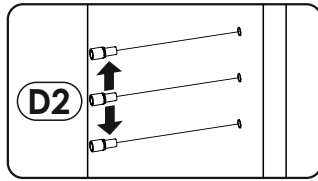
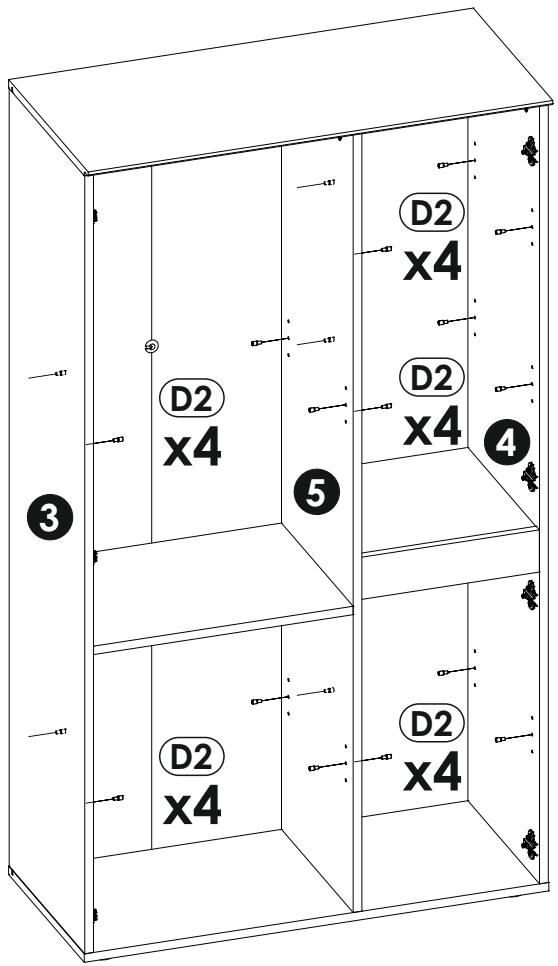

22 ▶

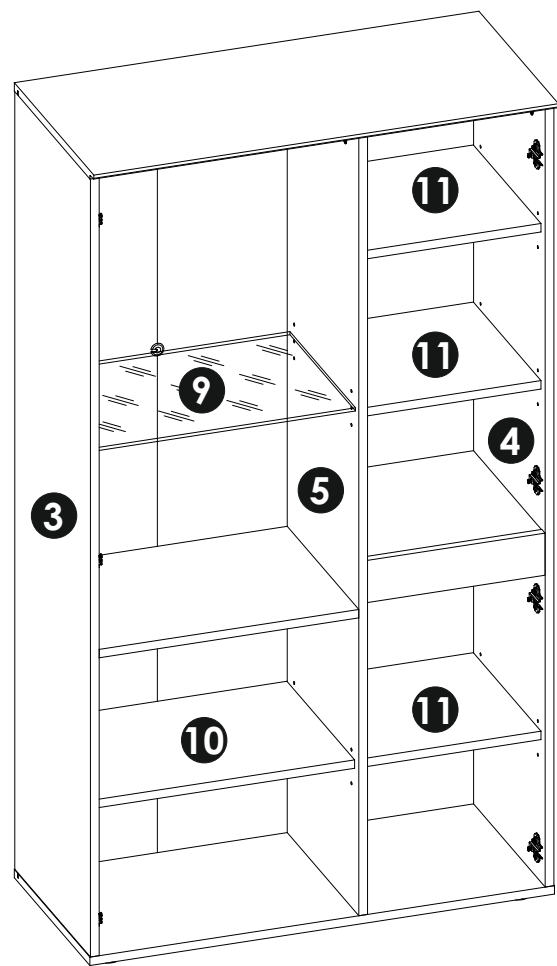
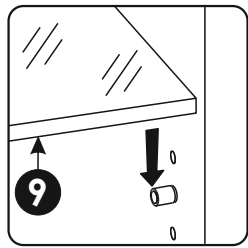
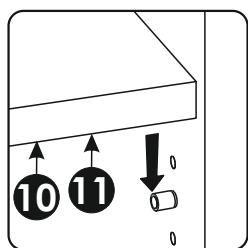

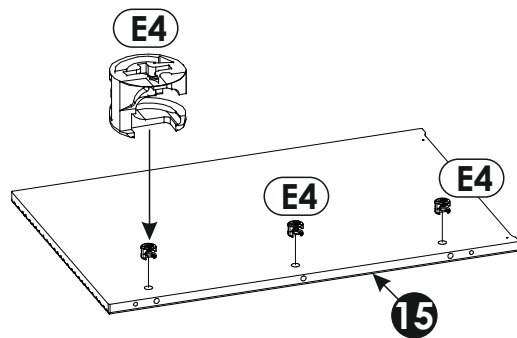
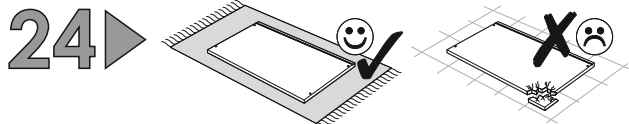
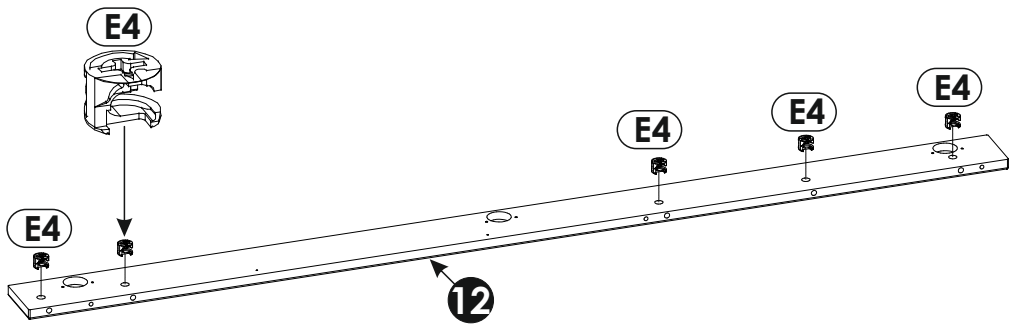
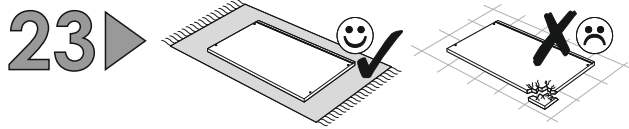

25▶

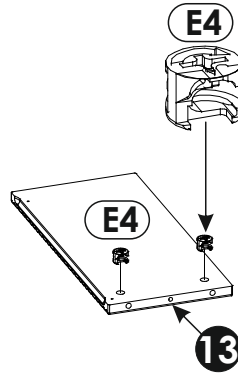
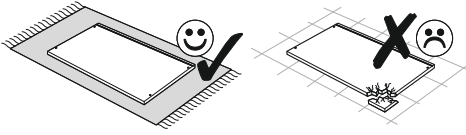

26▶

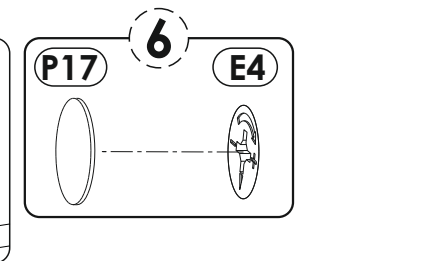
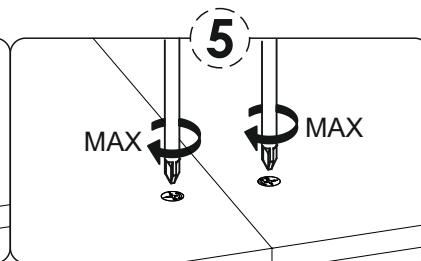
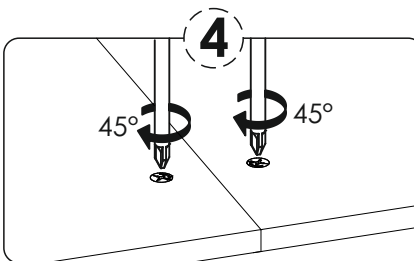
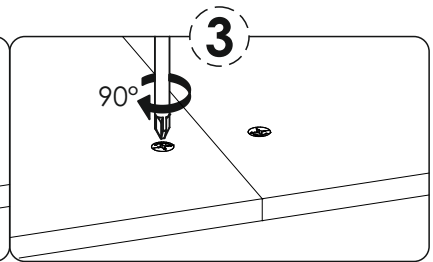
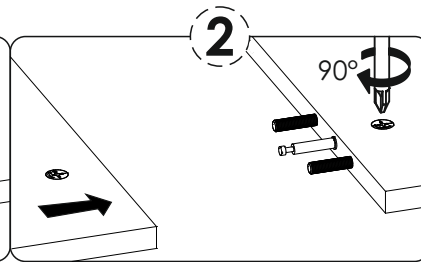
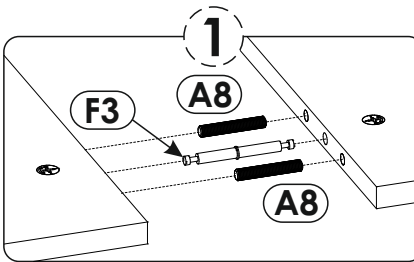
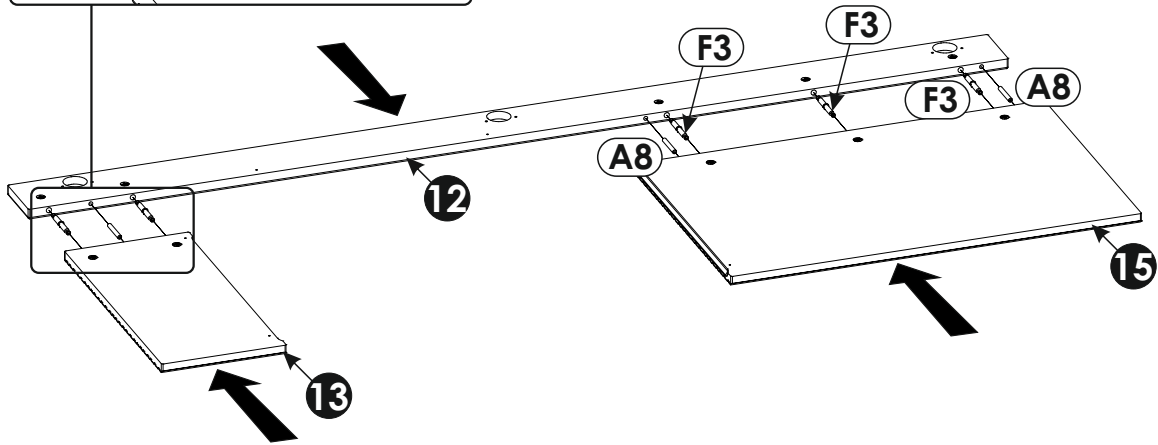
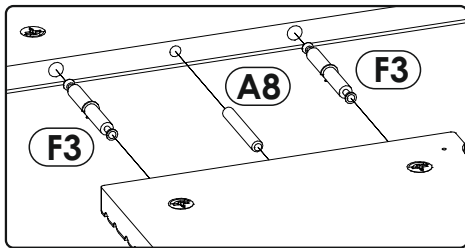
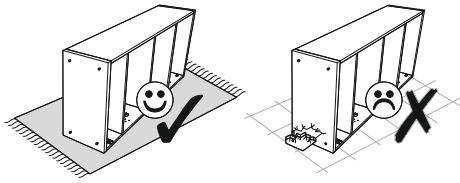

27 ▶

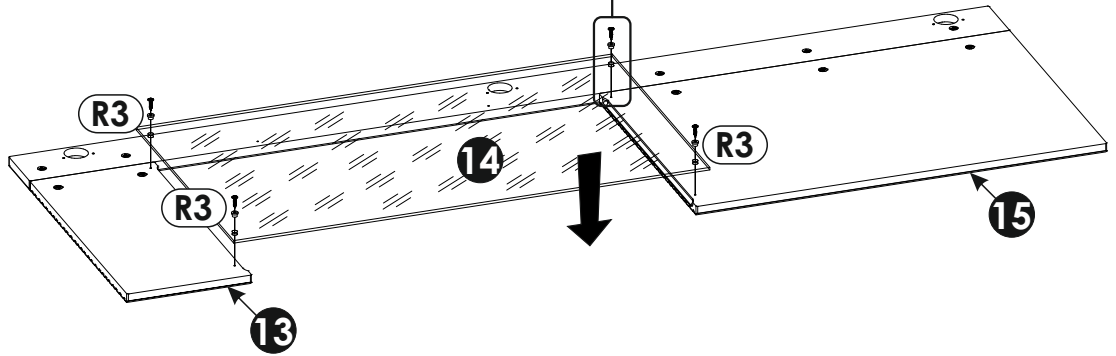
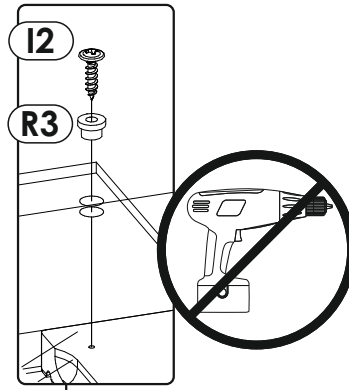
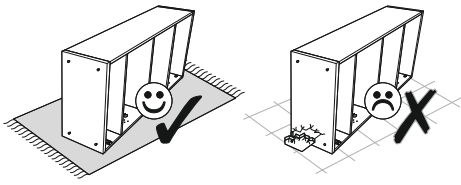

28 ▶

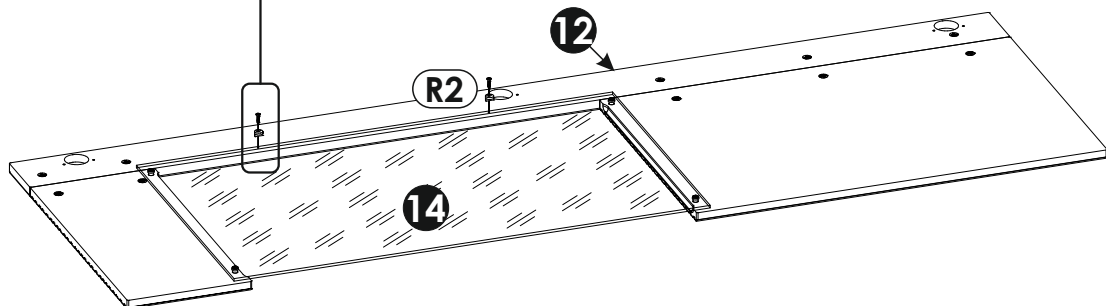
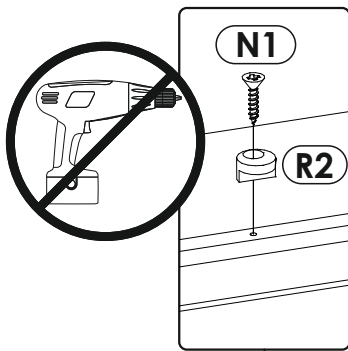
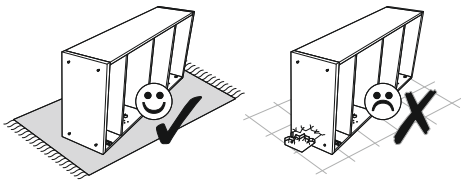

29 ▶

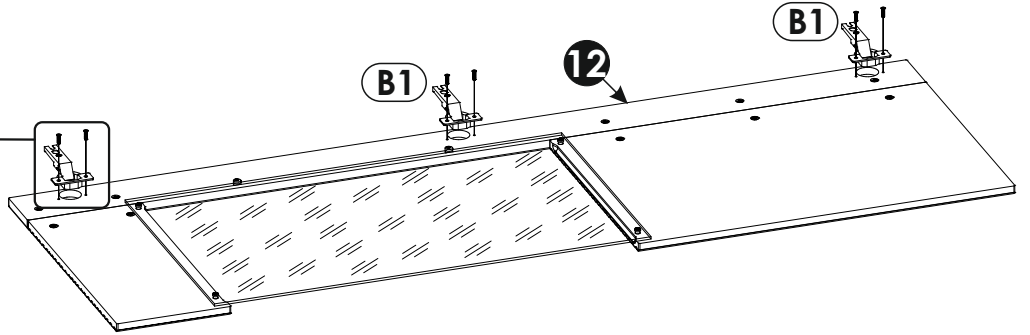
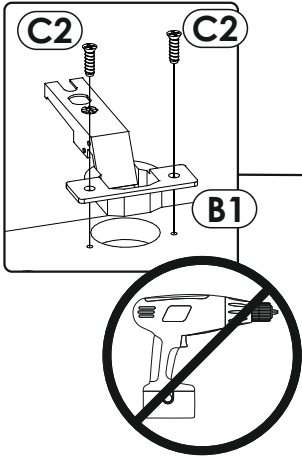
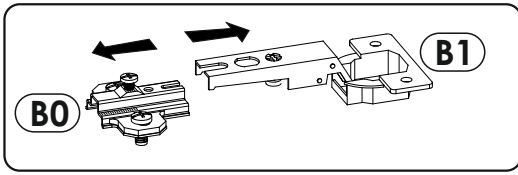
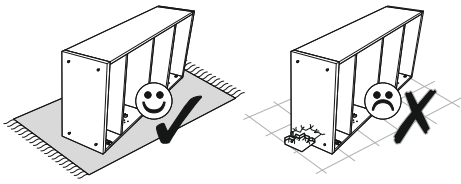

30 ▶

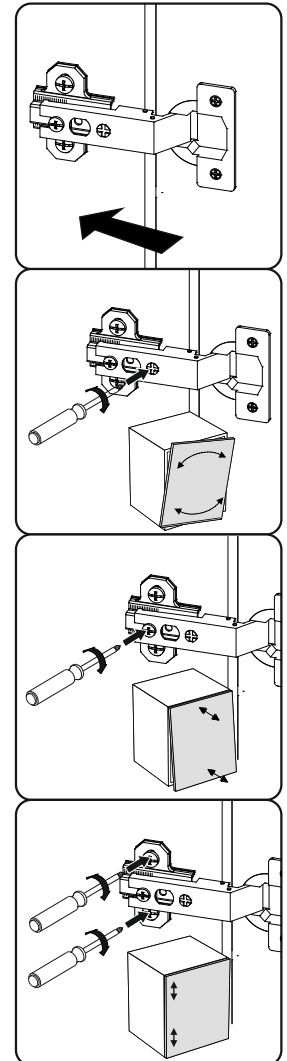
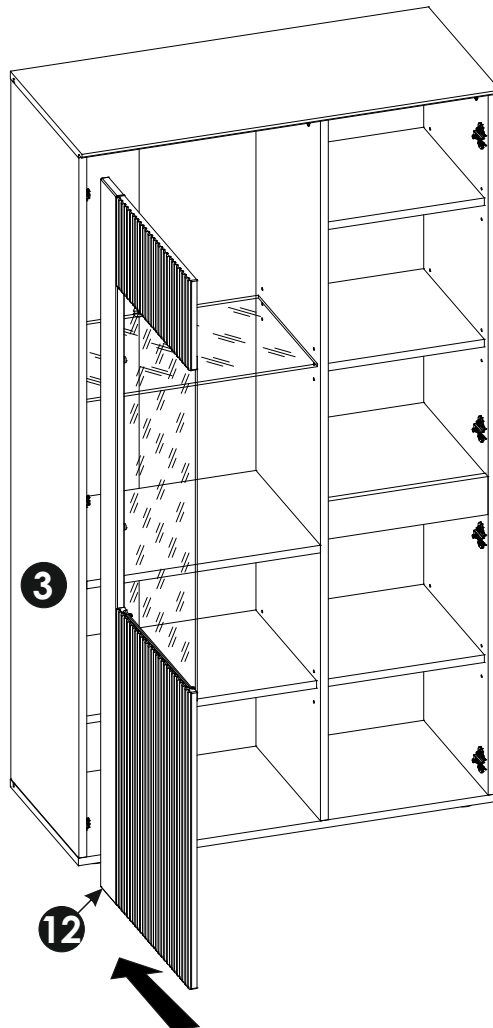
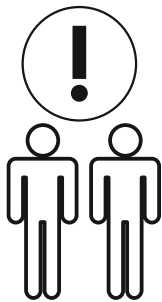

31 ▶

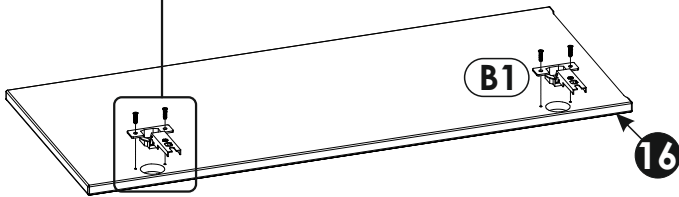
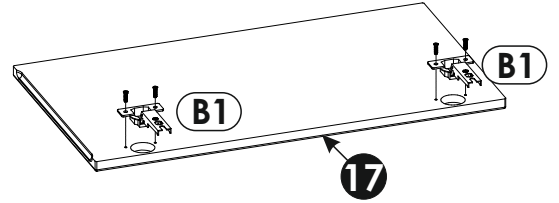
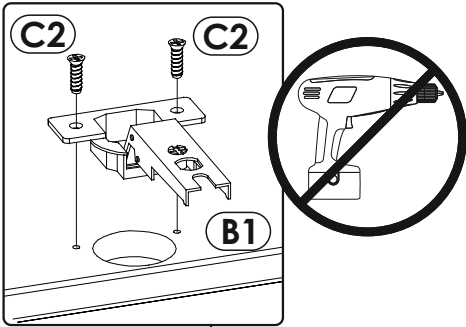
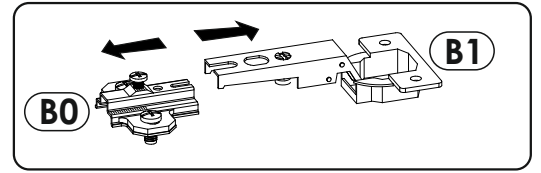
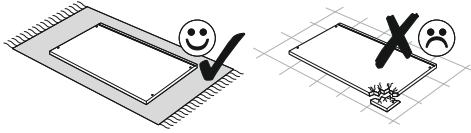

32 ▶

