



















A  x 14	B  x 14	C  x 11	D  x 1	E  (M4*22mm) x 2	F  (Ø3.5*10mm) x 8	G  (Ø4*30mm) x 4
H  x 4	I  (Ø3*14mm) x 4	J  x 14	K  x 4	CL  x 1	CR  x 1	DL  x 1
DR  x 1						

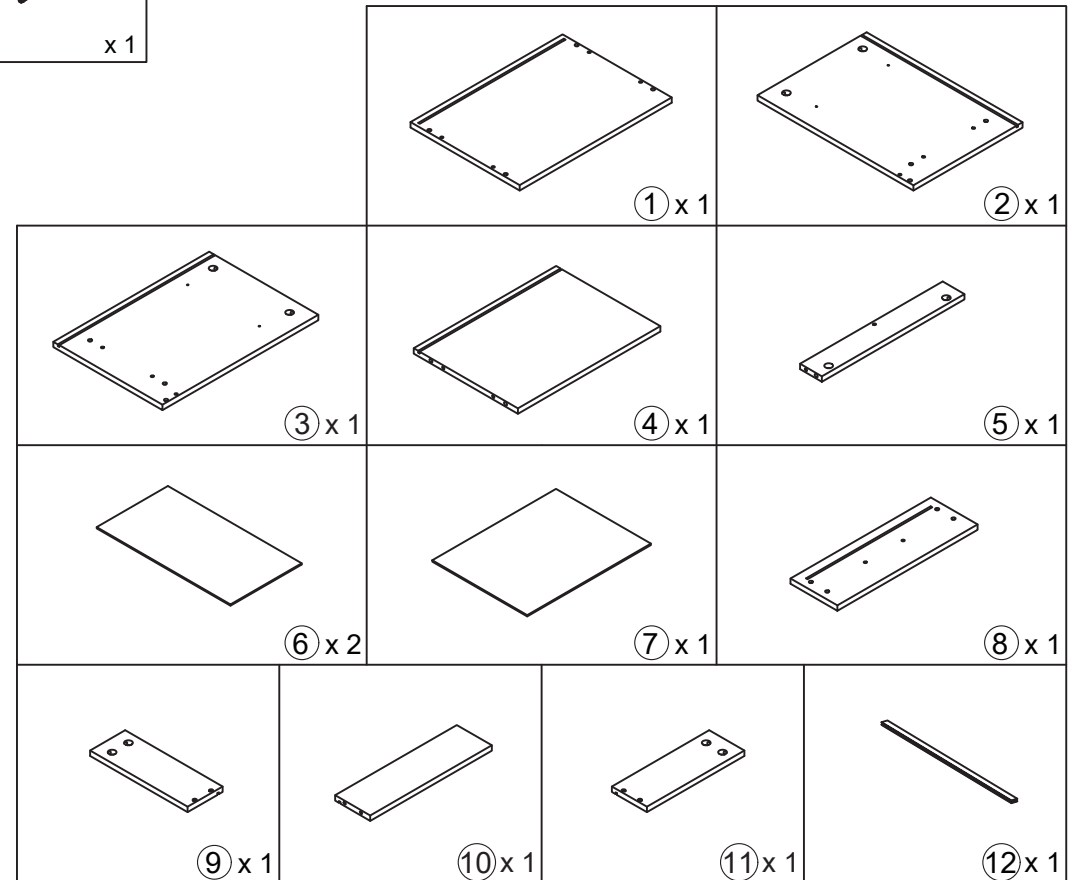

 x 2     
  30min

1

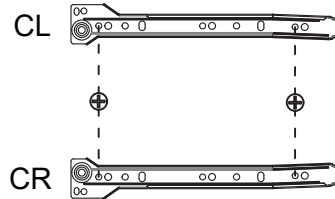
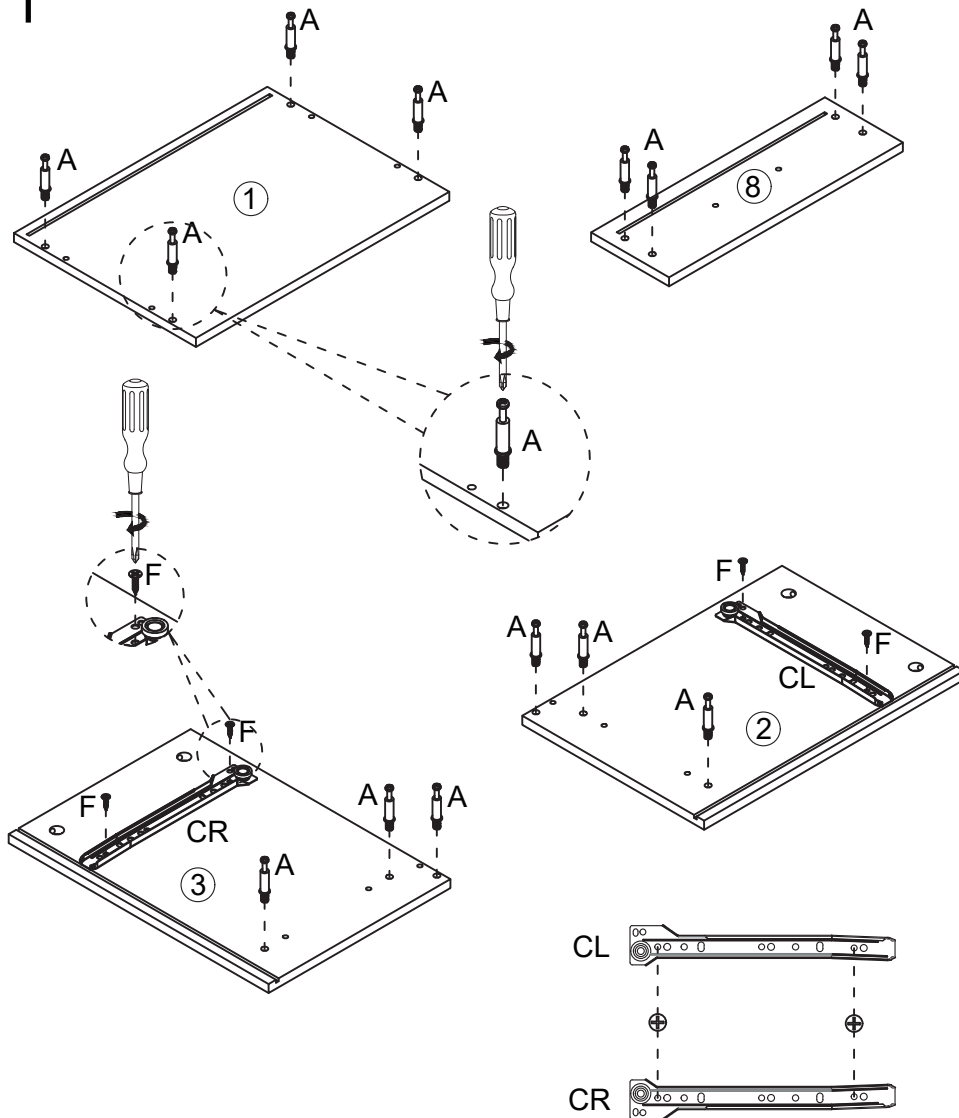

2

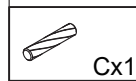
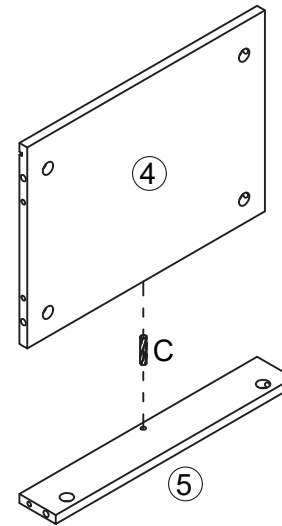

3

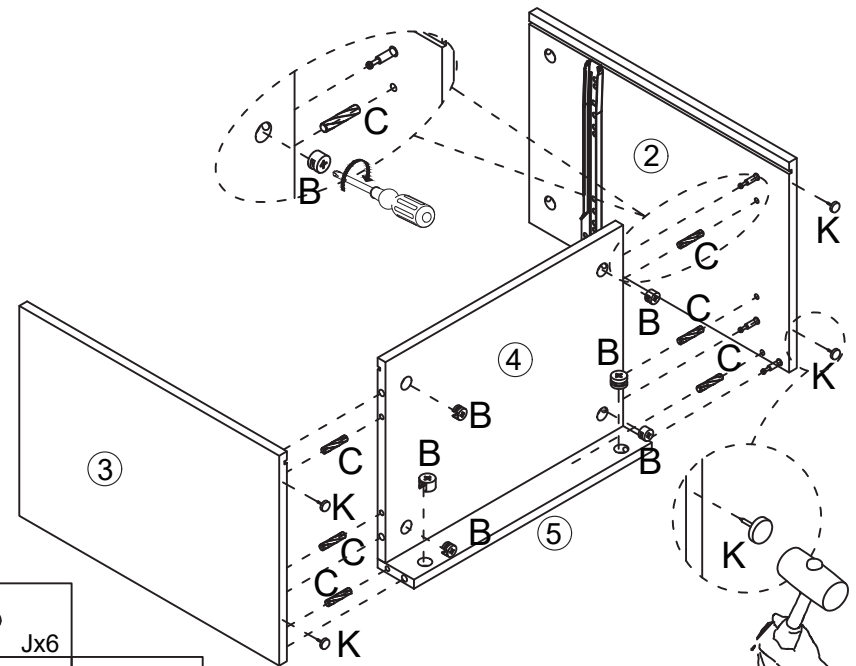
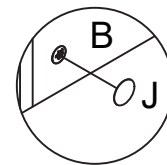
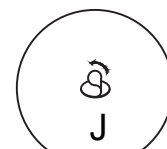

4

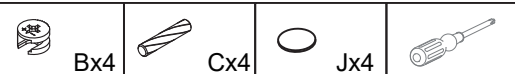
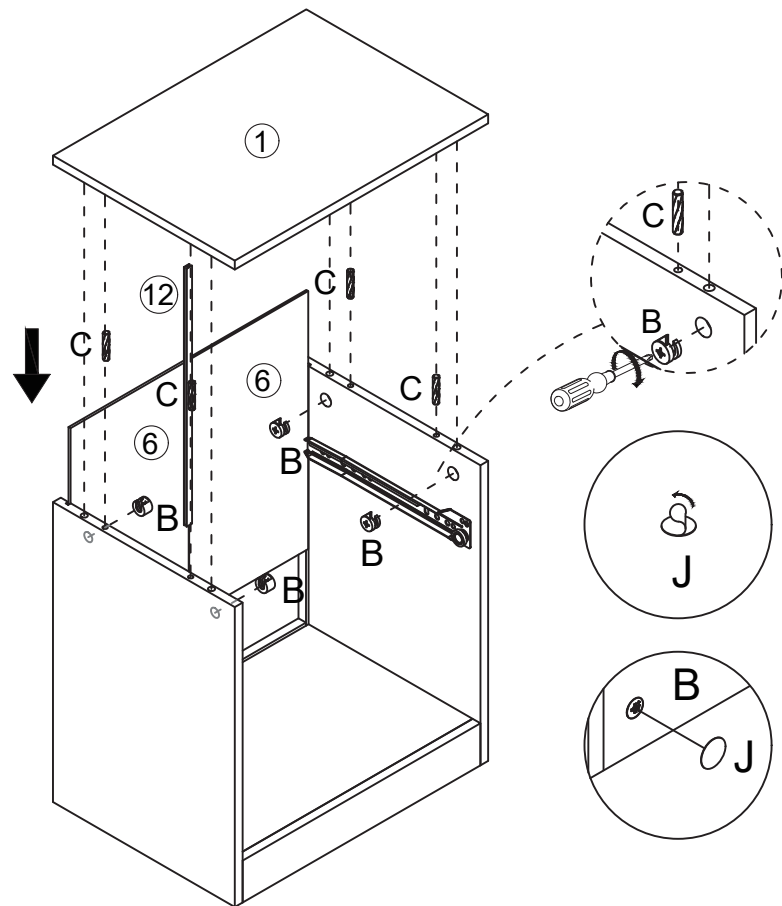

5

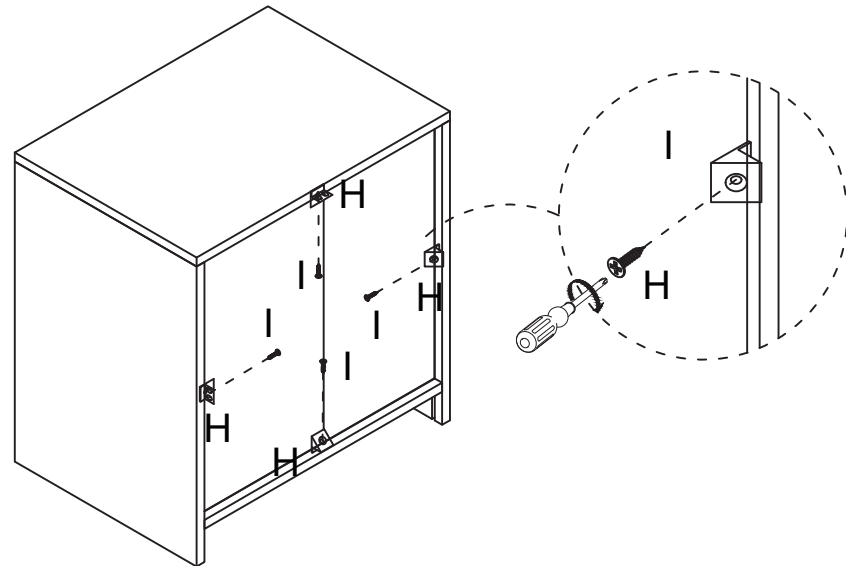

6

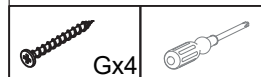
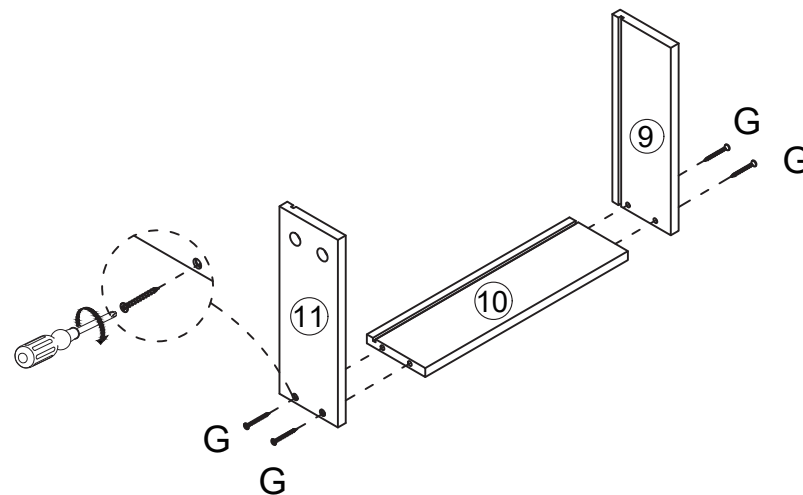

7

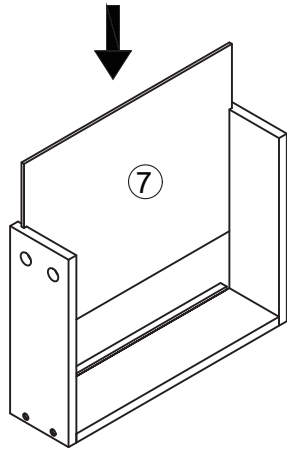

9

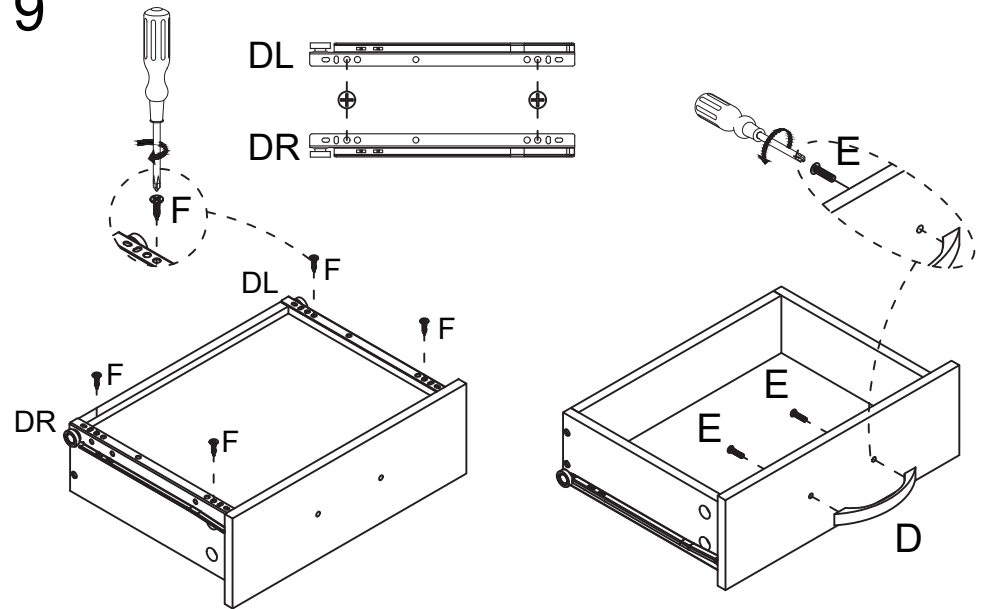

8

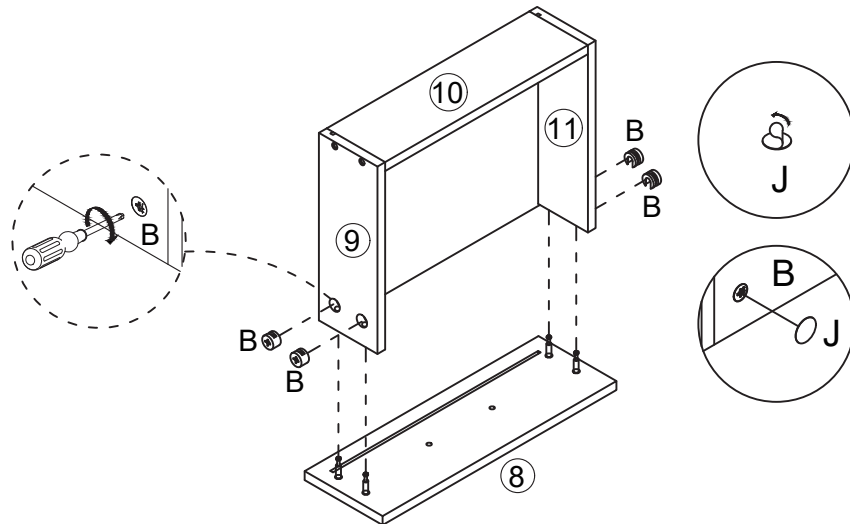

10

