

TROMSO

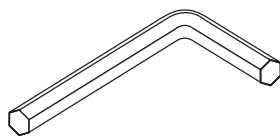

A



B

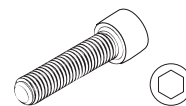

C

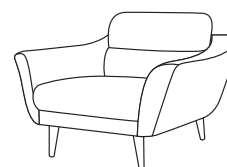
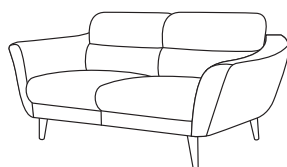
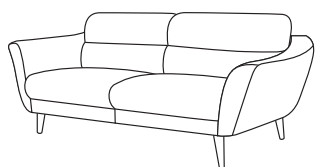

1

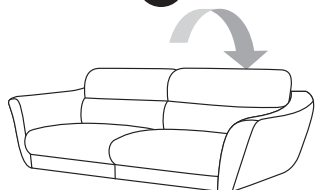

2

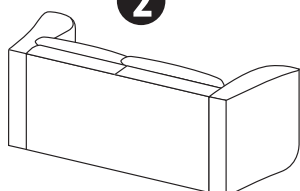

3

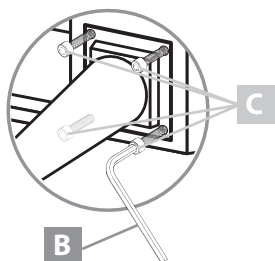
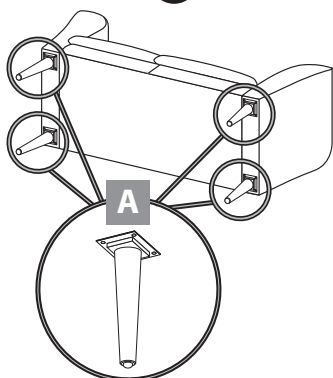

1



2

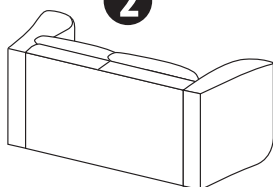

3

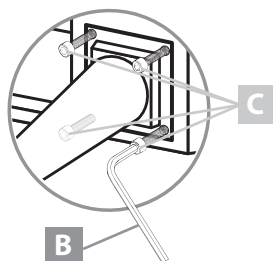
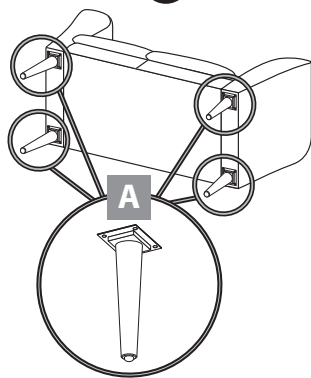

1



2

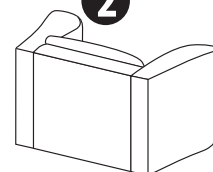

3

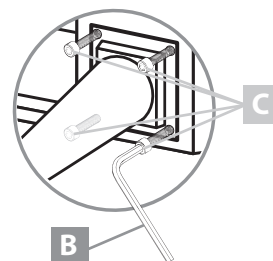
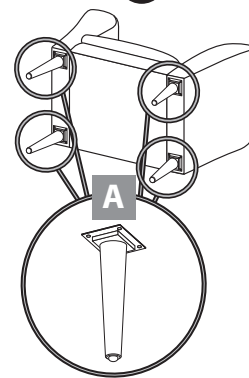

D Dieses Sofa hat eine lange und anstrengende Reise hinter sich. Bitte die Kissen vor Gebrauch schütteln und die Polsterung aufklopfen. Dies in regelmäßigen Abständen wiederholen, damit Sie lange Freude an ihrem Sofa haben.

F Il est possible que le transport ait entraîné une déformation des accoudoirs ou des coussins. Pour les remettre en éta initial, tapotez - les et secouez - les.

I Questo divano pu risultare compresso all'apertura dell'imballo, in seguito al trasporto. Vi preghiamo di scuotere e battere l'imbottitura prima dell'utilizzo per riportarla al suo stato normale. Ripetere questa procedura regolarmente.

E Your sofa has been on a long and strenuous journey. Please fluff the cushions up well before use and repeat this procedure regularly.

CZ Tento sedací nabytek má za sebou dlouhou a namahavou cestu. Před použitím je nutno calouneni natřepat a naklepat a toto opakovat v pravidelných intervalech.

NL Uw bank heeft een lange en inspannende reis achter de rug. Schud de kussens voor gebruik en doe dit regelmatig.

PL Państwa Sofa ma za sobą długą, wyczerpującą podróż. Proszę dobrze wyklepać, wygładzić poduszki oraz mebel. Czynność regularnie powtarzać, aby radość z posiadanej Sofy trwała jak najdłużej.

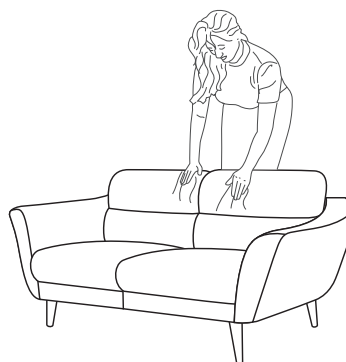

WARNING



Nawet przy zastosowaniu najwyższej jakości skór i tkanin pod wpływem ciężaru ciała są one rozciągliwe w mniejszym lub większym stopniu. Może to prowadzić do tworzenia się fałd. Zmiany optyczne nie mają wpływu na ich użyteczność, funkcjonalność i wytrzymałość - nie jest to wada materiału.